



# Tote Bag with Angled Handles

Design & work: Kokka Fabric

Size: about 30cm (l)  
about 50cm (W)  
about 14cm (d)  
(excluding handles)

## Materials

- Outer Fabric: 110cm wide×60cm
- Lining Fabric: 110cm wide x 70cm
- Fusible interfacing (Heavy weight) 110cm wide x 70cm
- ※ Adhere fusible interfacing on the back of the bag outer fabrics and handles.

Fabric shown for this sample: (Outer fabric) kitchen cloth P48000-801D

## Pattern

Unit: Centimeters (cm) 【 】: Seam allowance  
Add 1cm seam allowance when you cut the fabric unless otherwise stated.

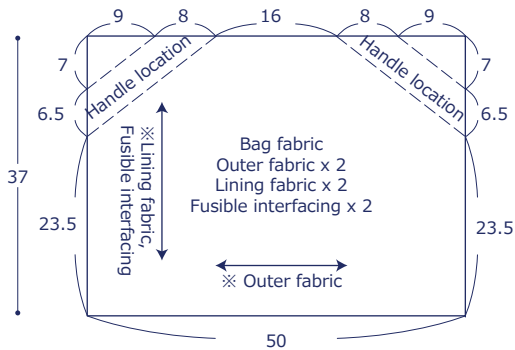
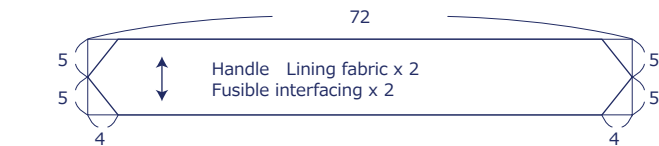

※ Adhere fusible interfacing on the back of the bag outer fabrics and handles.

have fun with KOKKA fabric! produced by **KOKKA**

[kokka-fabric.com](http://kokka-fabric.com)

The craft projects and works featured in kokka-fabric.com are strictly for personal use and enjoyment. Please refrain from selling handmade items using the same exact design (including the pieces made in different fabrics) featured in kokka-fabric.com.

## Instructions

1. Make the handles and attach them to the outer fabrics.

Fold the handle in four and run stitches on the long ends.

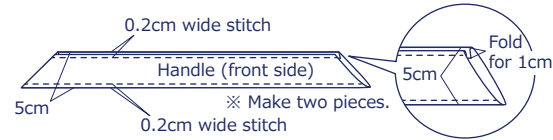

Fold the center of the handle in half and run stitches.

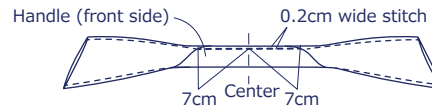

Attach the handle to the specified location.

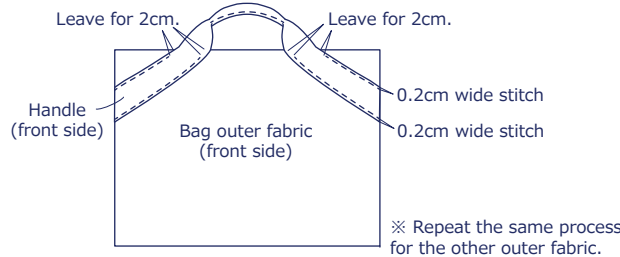

2. With the front sides facing each other, sew together the bag fabrics at the bottom.

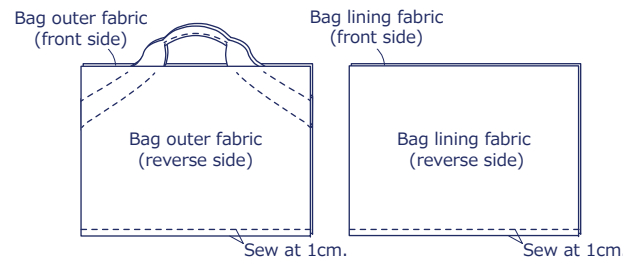

3. With the front sides facing each other, fold the gusset and sew together the bag fabrics at both sides.

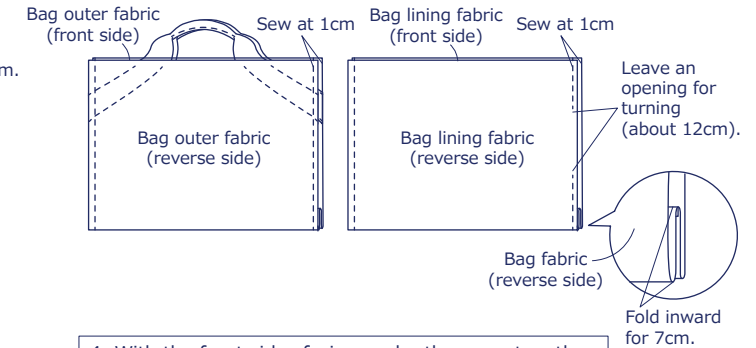

4. With the front sides facing each other, sew together the outer bag and lining bag at the top opening.

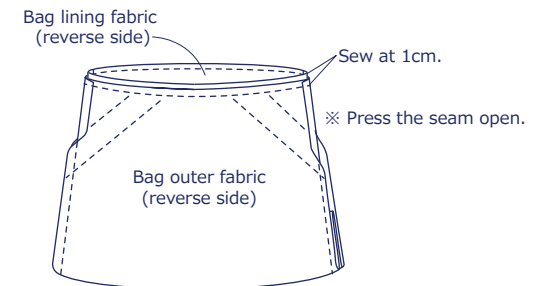

5. Turn the bag inside out and run stitches at the top opening.

