



School Bag and Indoor Shoe Case

Design & Work: Masumi Saito (sinafuku)

Size: Bag 28.5cm (l) 37cm (w) 4cm (d)
Shoe Bag 25.5cm (l) 18cm (w) 6cm (d)

have fun with KOKKA fabric! produced by KOKKA

kokka-fabric.com

The craft projects and works featured in kokka-fabric.com are strictly for personal use and enjoyment.
Please refrain from selling handmade items using the same exact design (including the pieces made in different fabrics) featured in kokka-fabric.com.

Materials

- Fabric (Outer Fabric a · Handle · Tab): 110cm×50cm
(Outer Fabric b): 70cm×40cm
(Lining Fabric): 70cm×70cm
- D Ring: One piece (2.5cm inner diameter)

Fabric shown for this sample: (Outer Fabric a, Handle, Tab) P43400-401 (c)

Pattern and cutting layout

All measurements are in centimeters (cm). Edges are left cut

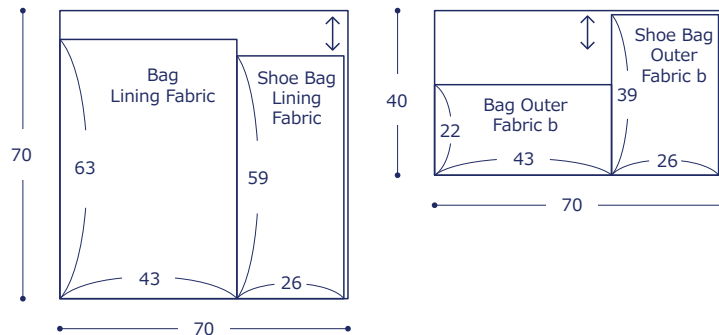
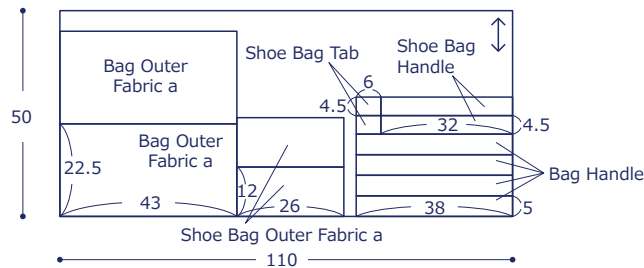

Instructions

<Bag>

1. Make the handles.

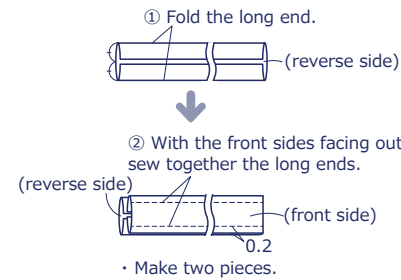

2. Make the bag.

① With the front sides facing each other, sew together the outer fabrics a and b.

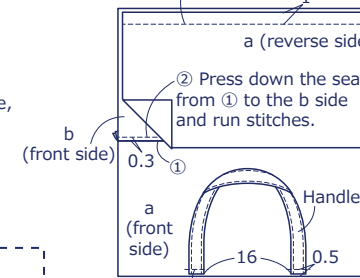

Outer fabric (front side)

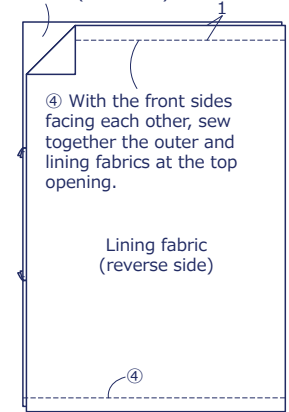

<Indoor Shoe Bag>

1. Make the handle and tab.

<Handle>

Make one handle as in Step 1 of the bag making process.

<Tab>

① Make the tab using the same process for the handle.

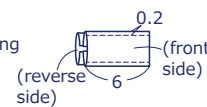

② Put through the D ring, fold in half and baste.

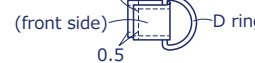

② Fold the handle in two and baste it to the bag.

2. Make the bag.

① Make the outer fabric using the same process for the bag Step 2 process ①②.

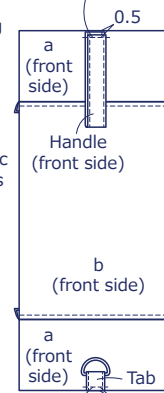

④ Make the bag using the same process for the bag Step 2 process ④~⑧. (Gusset is 6cm)

③ Baste the tab.

⑤ As shown, re-fold the fabric and sew the sides (Leave an opening for turning on one side).

