



# Vanity Style Pen Case

Design & work: Yoko Kubodera

Size: 18cm (l) 8cm (bottom diameter)

have fun with KOKKA fabric! produced by **KOKKA**

[kokka-fabric.com](http://kokka-fabric.com)

The craft projects and works featured in kokka-fabric.com are strictly for personal use and enjoyment. Please refrain from selling handmade items using the same exact design (including the pieces made in different fabrics) featured in kokka-fabric.com.

## Materials:

- Fabric (Outer fabric): 40cm×25cm  
(Lining fabric, Handle, Bias binding strip): 60cm×30cm
- Fusible quilt batting: 40cm x 25cm
- Cotton herringbone tape: 70cm (2cm width)
- Cord: 50cm (0.5cm diameter)
- Rope: 9cm (0.5cm diameter)
- Flat knit zipper: one piece (20cm)

Fabric shown for this sample: (Outer fabric) echino JG96900-903A  
(Lining fabric, Handle, Bias binding strip) JG95410-101

## Pattern and Cutting Layout

Unit: cm. Add 1cm seam allowance unless otherwise specified.

Outer fabric  
※ Cut the fusible quilt batting with the same dimension and attach it to the back of the outer fabric.

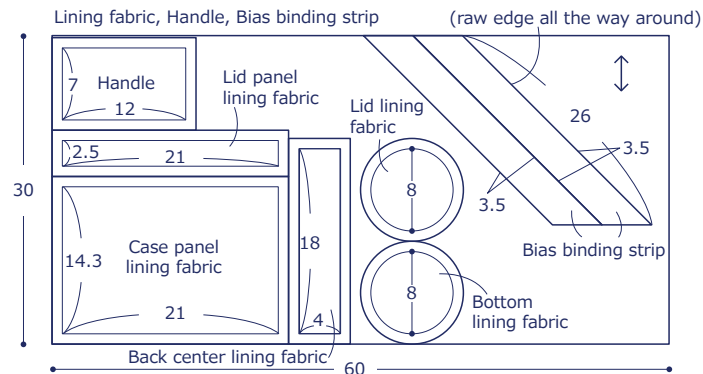
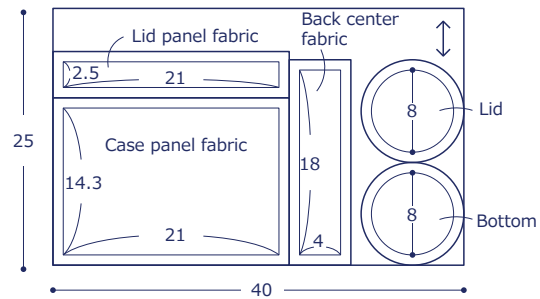

## Instructions

### 1. Make the piping cord.

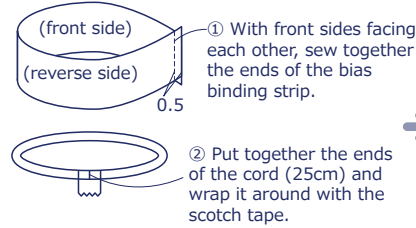

### 2. Make the handle.

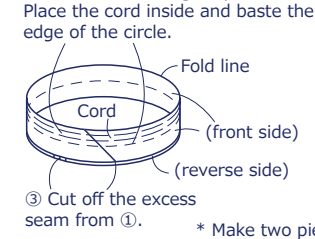

### 3. Make the panels.

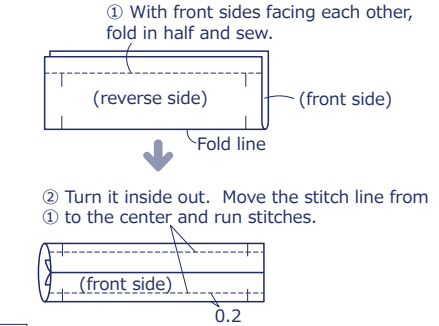

### 4. Attach the back center fabric.

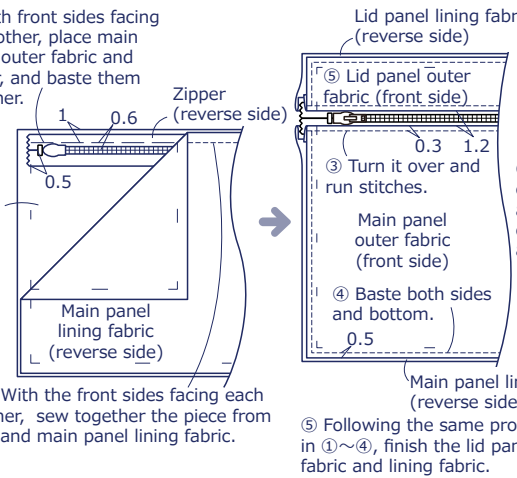

### 5. Attach the lid.

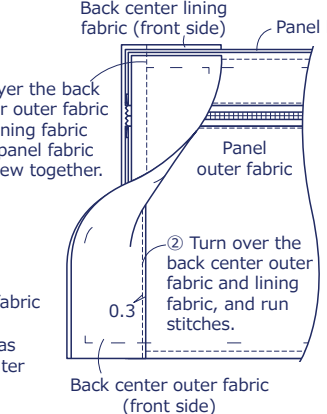

### 6. Attach the bottom.

