



Drawstring Bag for Yukata (Cotton Kimono for Summer)

Design & Work: Anriko

Size: 25cm (l) 9cm (bottom diameter)

have fun with KOKKA fabric! produced by KOKKA

kokka-fabric.com

The craft projects and works featured in kokka-fabric.com are strictly for personal use and enjoyment. Please refrain from selling handmade items using the same exact design (including the pieces made in different fabrics) featured in kokka-fabric.com.

Materials (for one bag)

- Fabric (Bag panel outer fabric, Bottom, Cord loop): 80cm×30cm
(Bag panel lining fabric): 62cm×27cm
- Cardboard paper or PP (polypropylene) sheet: 9cm diameter
- Cord: 1.2m (0.2cm diameter)

Fabric shown for this sample: (Bag panel outer fabric, Bottom, Cord loop)
EKA-1050-1A, EKA-1050-2A

Pattern & Cutting Layout

Unit: cm. All raw edge.

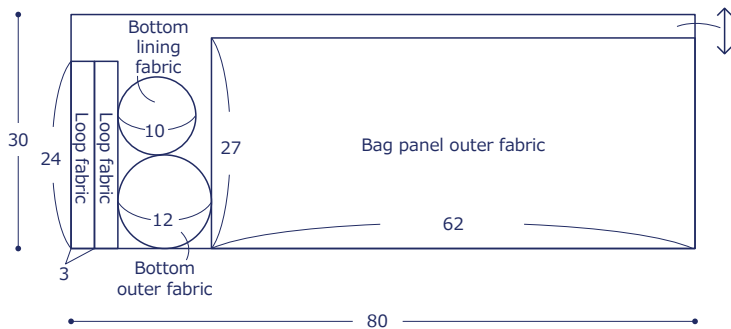

Instructions

1. Make the loop for a cord

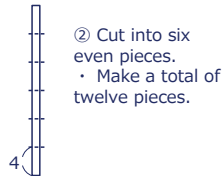
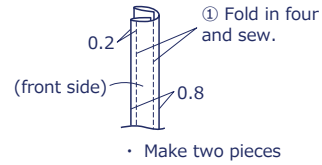

2. Make the bag panel

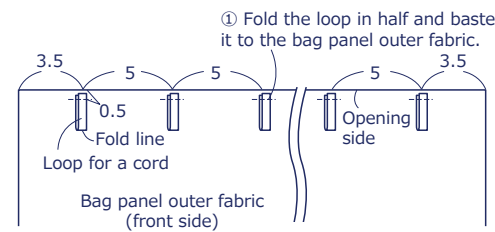

③ Open it and fold with the front sides facing each other, then sew the side.

Bag panel lining fabric (front side)

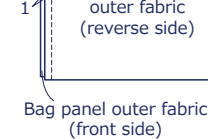
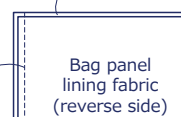

② With the front sides facing each other, sew together the outer and lining fabrics at the top opening.

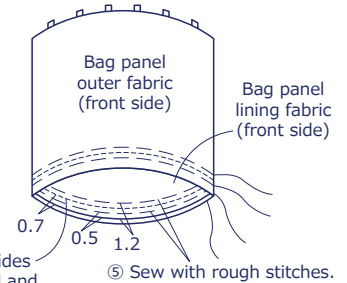
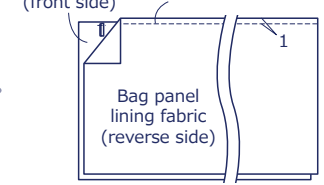

④ With the front sides facing outside, fold and baste the bottom.

3. Attach the bottom lining fabric

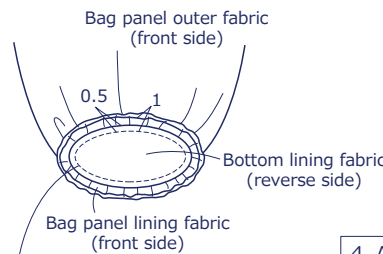

① Pull the thread from [2] - ⑤ and shrink it to the finished dimension. With the front sides facing each other, sew together the bag panel lining fabric and bottom lining fabric.
② Pull off the thread from [2] - ⑤.

4. Attach the bottom outer fabric to finish

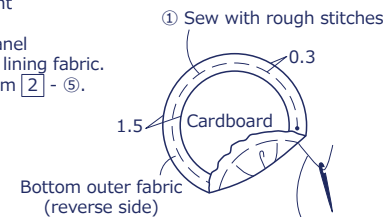

② Layer the cardboard and pull the thread from ① to tighten.

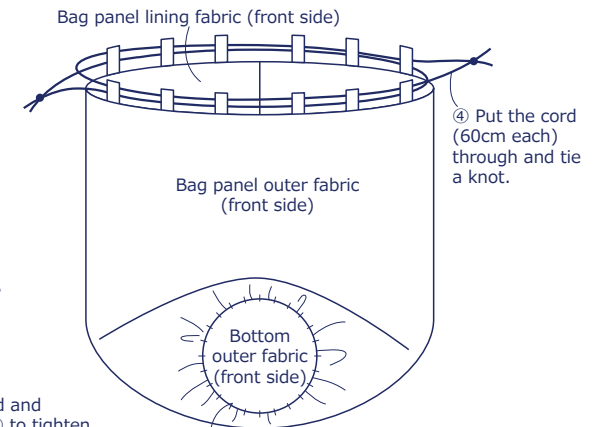

③ Attach the bottom outer fabric using blind stitches.