



Marché Bag

Design & work: Kokka Fabric

Size: about 26cm (l)
about 48cm (w)
about 30.6cm (d)

have fun with KOKKA fabric! produced by KOKKA

kokka-fabric.com

The craft projects and works featured in kokka-fabric.com are strictly for personal use and enjoyment. Please refrain from selling handmade items using the same exact design (including the pieces made in different fabrics) featured in kokka-fabric.com.

Materials

- Outer fabric 110cm wide x 60cm
- Lining fabric 110cm wide x 60cm
- Fusible interfacing (medium weight) 90cm wide x 80cm
- Handle tape 4.5cm wide x 94cm

Fabric shown for this sample: YK-56150-2A

Pattern and Cutting Layout

Unit: cm. [] denotes seam.

When cutting the fabric, add 1cm seam unless otherwise stated.

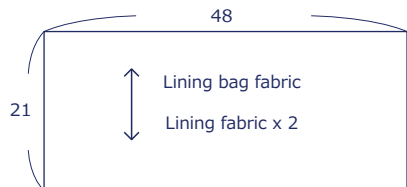
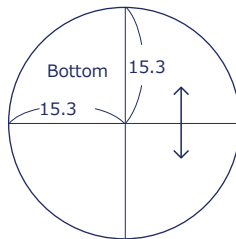
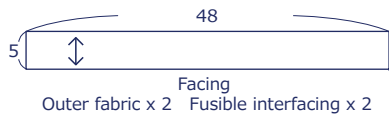
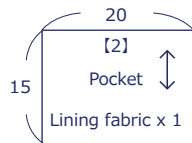
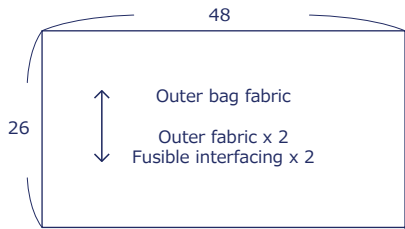

Outer fabric x 1
Lining fabric x 1
Fusible interfacing x 1

※ Adhere fusible interfacing on the back of the outer fabrics.

Instructions

① Make the pocket and attach it to the lining bag fabric (only one side).

Double fold the pocket opening and sew.
Fold the seam on the surrounding ends for 1cm.

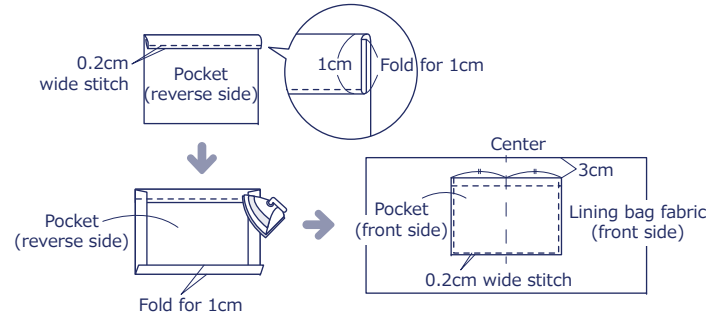

② With the front sides facing each other, sew together the lining bag fabric and facing.

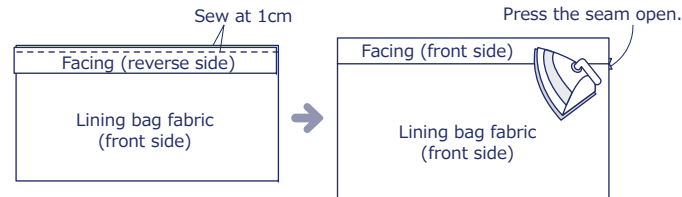

③ With the front sides facing each other, sew together the bag fabrics at the side.

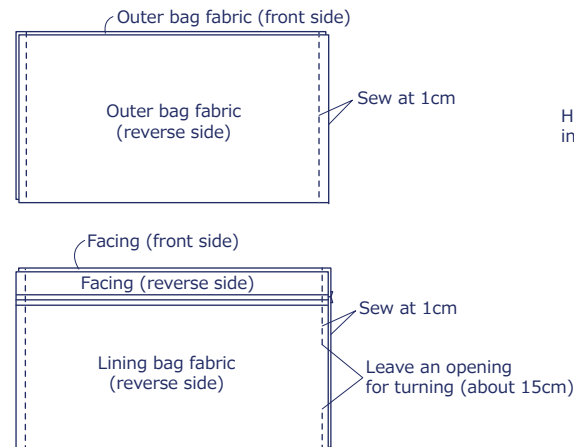

④ With the front sides facing each other, sew together the bag tube portion and bottom.

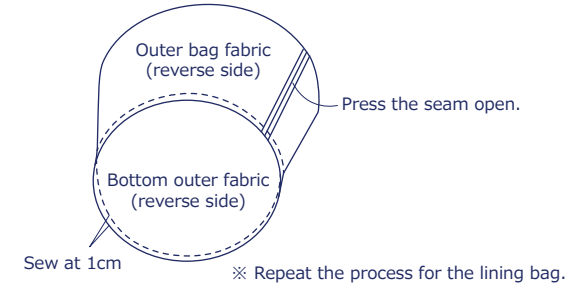

⑤ With the front sides facing each other, sew together the outer bag and lining bag at the top opening. Using the opening for turning, turn the bag inside out and apply stitches at the top opening.

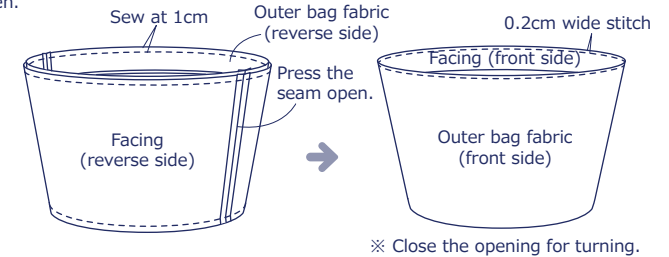

⑥ Attach the handle tape to the bag fabric to finish.

