



Heart Shaped Pouch

Design & work: Mioko Sugino

Size: Body approx. 12cm (l)
approx. 12cm (w)
4cm (gusset)
Strap 1cm(w) approx. 13cm (l)

Materials

- Fabric (Outer Fabric, Strap, Bias Binding Fabric): 65cm×40cm
- Fabric (Lining Fabric): 30cm×40cm
- Fusible Interfacing: 30cm×30cm
- Tape: 1cm wide x 4cm
- Swivel Hook: One piece (1cm inner diameter)
- D Ring: One piece (1cm inner diameter)
- Flat Knit Zipper: One piece (20cm)

Fabric shown for this sample:EGX-9600-4A

Pattern and Cutting Layout

Unit: cm [] : denotes seam allowance Add 1cm seam allowance unless otherwise stated.
Adhere fusible interfacing to the back of the [] area.

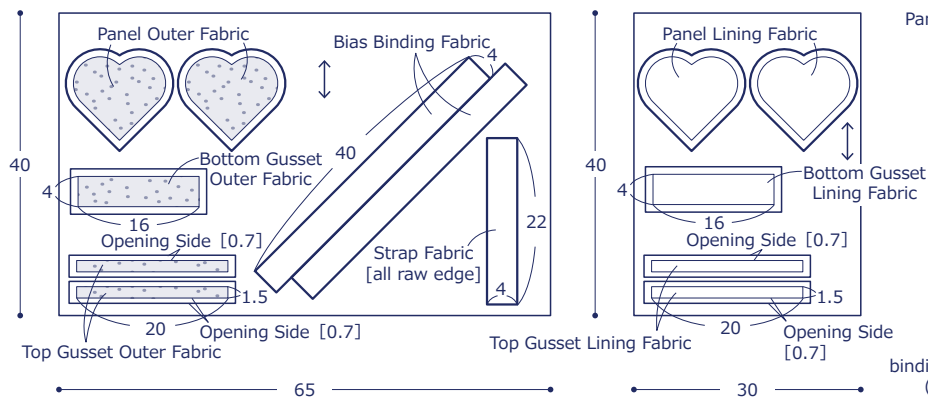

Instructions Front Side - (FrS), Reverse Side (RvS)

1. Make the back panel

①With the front sides facing outside, put together the outer and lining fabrics and sew the perimeter with zigzag stitches.
②Cut a slit.

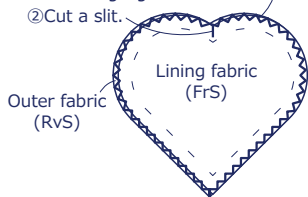

③Thread the D-ring through the tape, fold it in half, and baste.

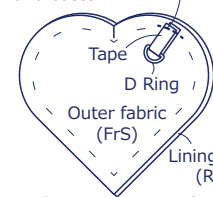

4. Make the body

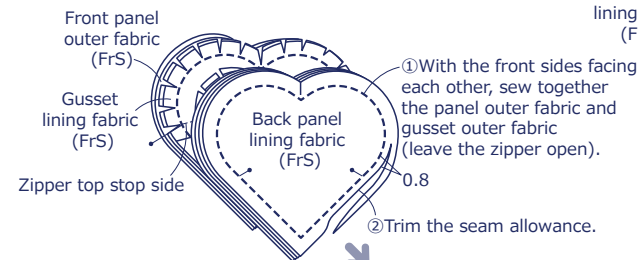

①With the front sides facing each other, sew together the panel outer fabric and gusset outer fabric (leave the zipper open).
②Trim the seam allowance.
③With the front sides facing each other, sew together the gusset lining fabric and bias binding fabric over stitch line from ①.

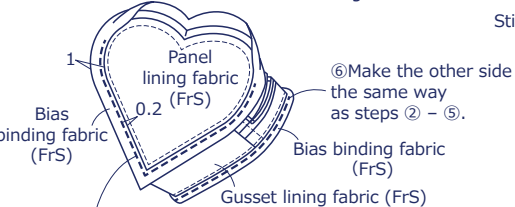
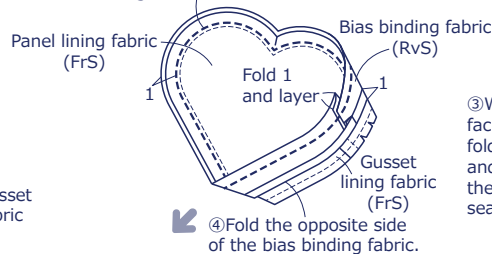

⑤With the front sides facing outside, fold the bias binding fabric in half. Wrap the seam allowance and sew.

2. Make the top gusset

①With the front sides facing each other, sew together the outer fabric and lining fabric at the top opening with a zipper in-between.

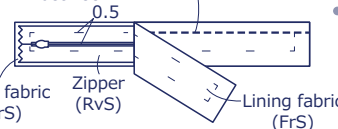

3. Make the gusset

①With the front sides facing each other, sew together the bottom gusset outer fabric and lining fabric with the top gusset in-between.

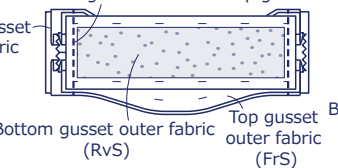

5. Make the strap and finish

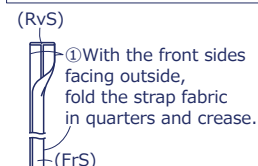

③With the front sides facing outside, fold in quarters again and sew. Adjust the stitched seam from ②.



②Thread the swivel hook, then open the fold from ①. With the front sides facing each other, sew both ends together.

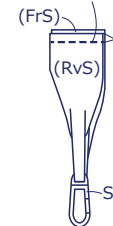

④Sew in place.

⑤Attach the strap to the D ring on the body.

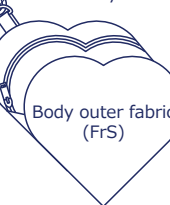

③Make the other side of the zipper in the same way as steps ① and ②.

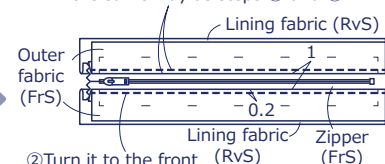

②Turn it to the front (RvS) and apply stitches.

③Cut a slit on the center of the top gusset and bottom gusset seam allowance.

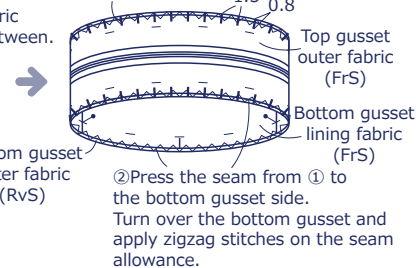

②Press the seam from ① to the bottom gusset side. Turn over the bottom gusset and apply zigzag stitches on the seam allowance.

"Real scale pattern of the panel"

☆Enlarge to 200% and cut out the pattern with seam allowances included.

