



Tulip print mini Boston bag

Finished Measurement: 21cm(W) x 14.5cm(H) x 5.5cm (D)

Materials

- Outer fabric (cotton/linen canvas): 110cm(L) x 30cm(W)
- Lining (cotton/linen canvas): 110cm(L) x 30cm(W)
- Interfacing: 100cm(L) x 35cm(W) 1 zipper 30cm

Fabric shown for this sample Outer body: FOLK MODERN Tulips JG41600-4 (C)

INSTRUCTIONS

Preparation

Cut out all fabrics and interfacings. Fuse interfacing to wrong side of outer fabric's pieces; body panels, zipper gussets, a bottom gusset, and handles.

1. Make handles

① Sew each handle. Fold all 4 sides of each handle patch to hem.

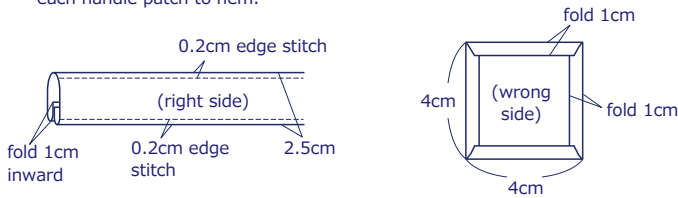

② Baste a handle on each outer body panel. Put a patch on each handle and sew around seam of the patch.

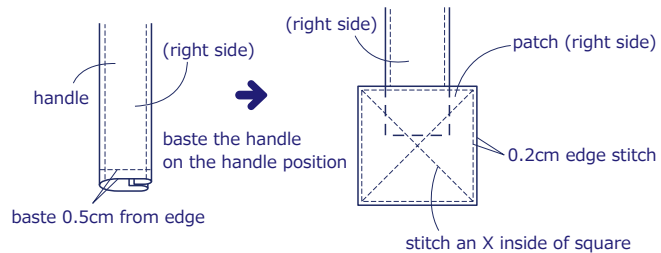

2. Attach the zipper

Attach the zipper to the outer zipper gusset. For each lining zipper gusset, press one of long edges of wrong side in 1.5cm inward

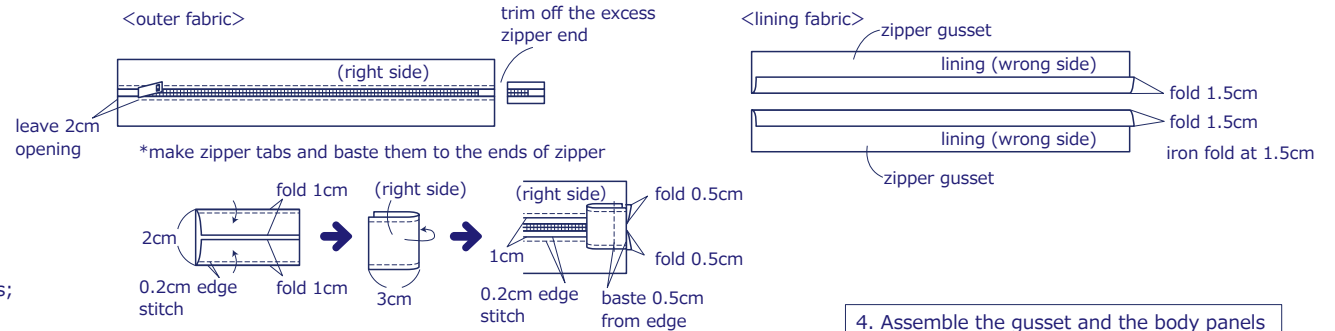

3. Sew zipper gusset and bottom gusset together

Sew zipper gusset and bottom gusset together of outer fabric. Repeat this step on the lining.

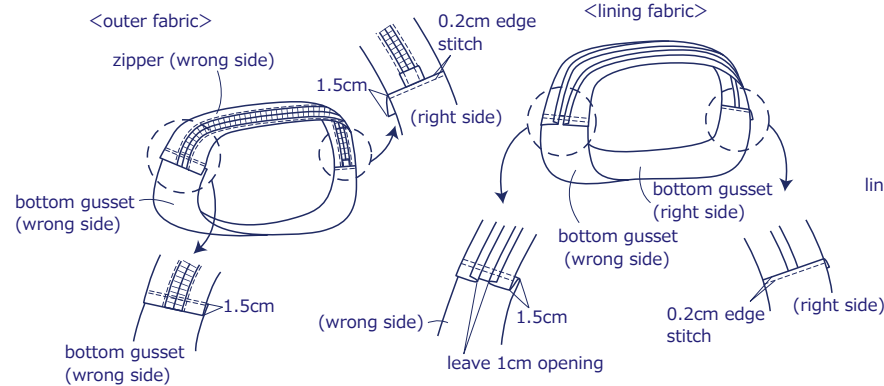

5. Get together outer and lining bodies

Put the lining body over the outer body. Sew all around of zipper line of lining by blind stitch.

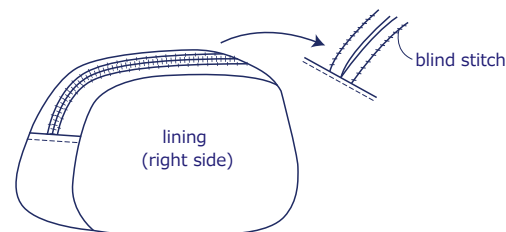

4. Assemble the gusset and the body panels

Sew the outer gusset and outer body panels together. Repeat this step on the lining.

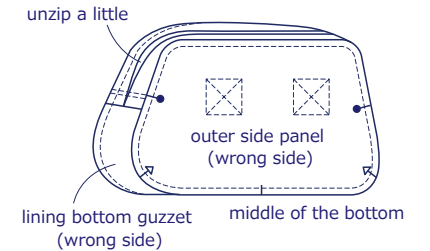

pull the outer through, turning the bag right side out.

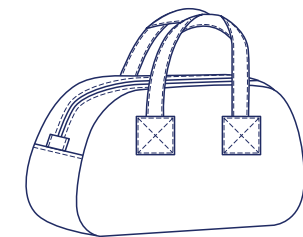

Tulip print mini Boston bag

full size pattern pieces

numbers of circles denote seam allowance

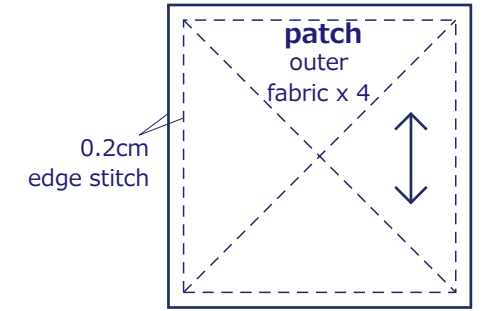
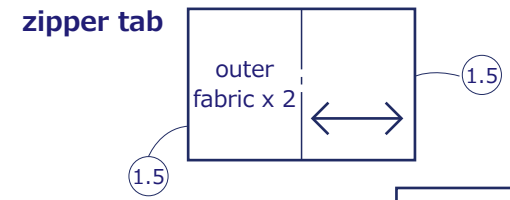
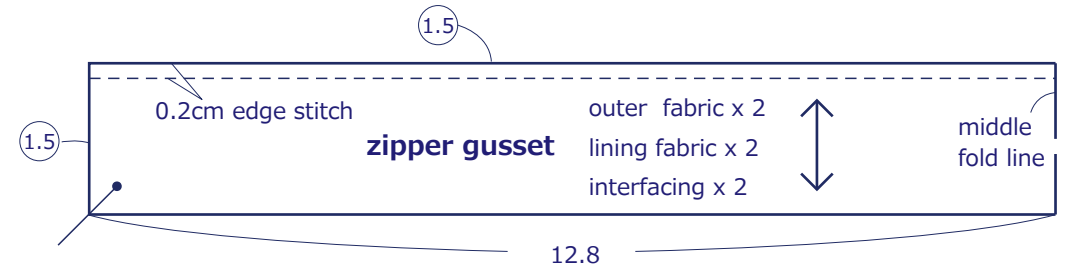
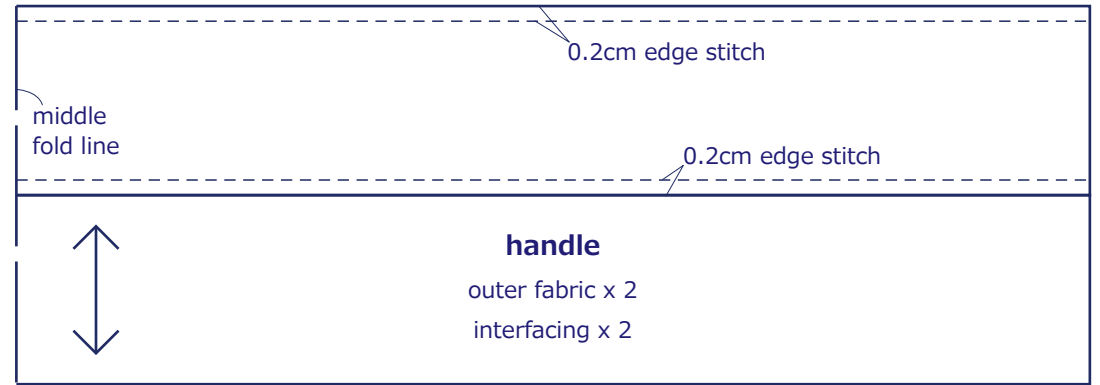
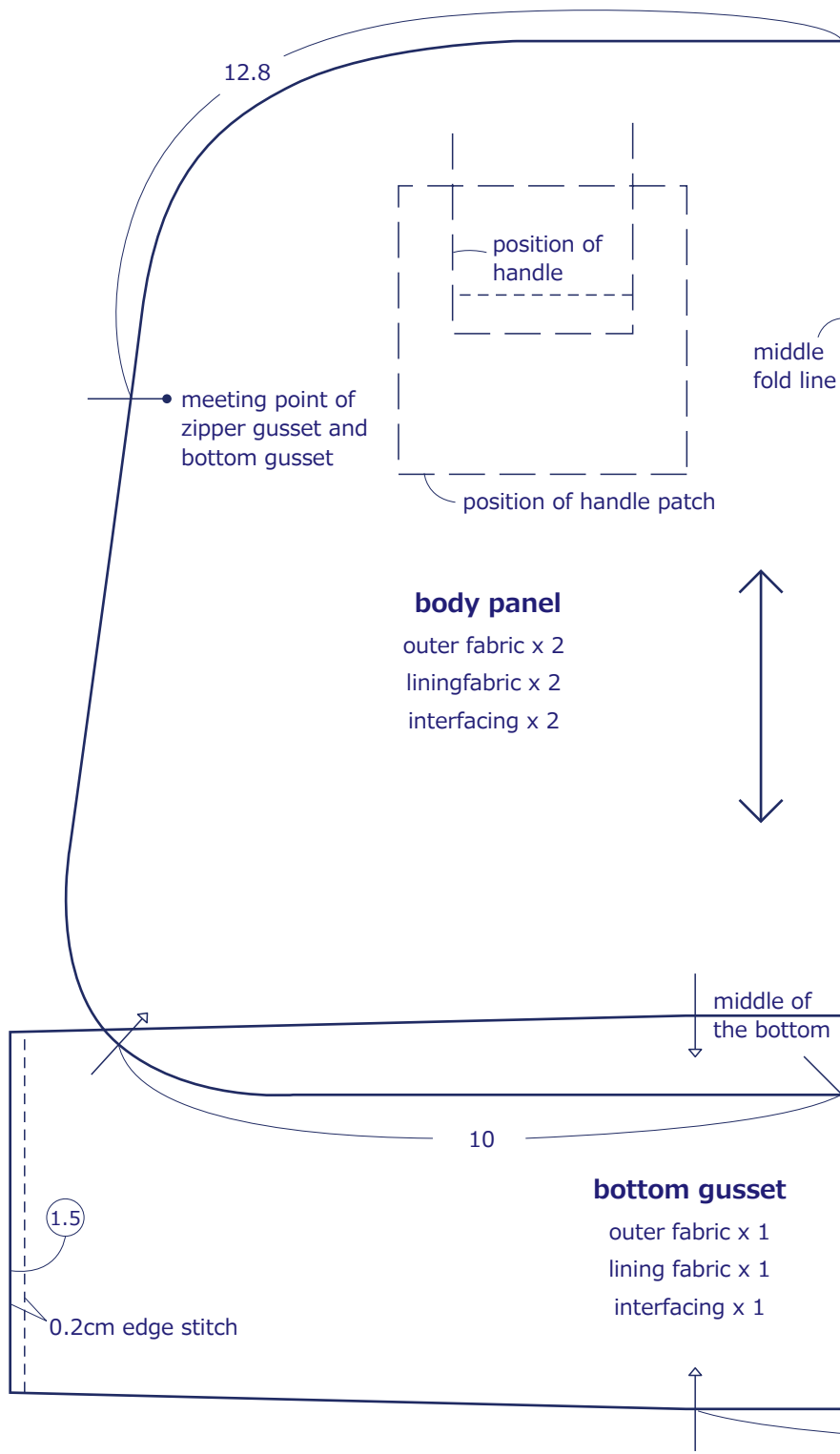

have fun with KOKKA fabric! produced by KOKKA

kokka-fabric.com