



Cami Dress

Design & work created by Kayo Shimizu

Size: Dress length 80cm

have fun with KOKKA fabric! produced by **KOKKA**

kokka-fabric.com

Materials

- Fabric: 150cm×120cm
- Elastic Tape: 60cm (1cm width)

Fabric shown for this sample: echino JP95210-10 (A)

Pattern and Cutting Layout

All measurements are in centimeters (cm).

Pattern

Body
(same for front and back)

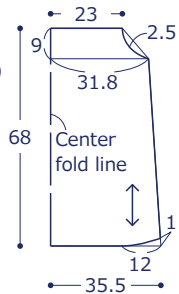

Cutting layout

Numbers in () denote seam allowance.
All seam allowances 1cm unless otherwise stated.

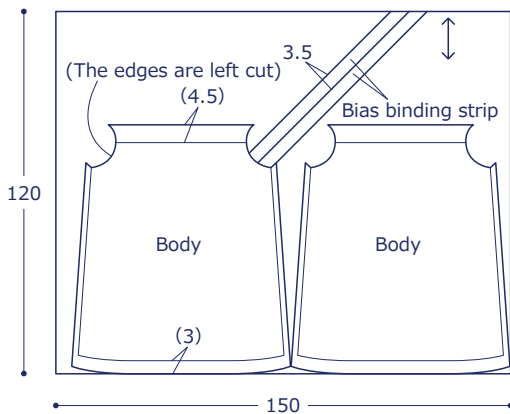

Instructions

1. Put the elastic tape.

① Double fold the top seam allowance and sew.

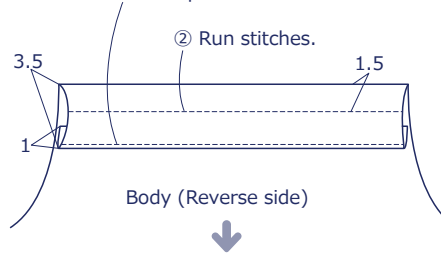

2. Finish the armhole.

① With front/outer sides facing outside, fold the bias binding strip in four.

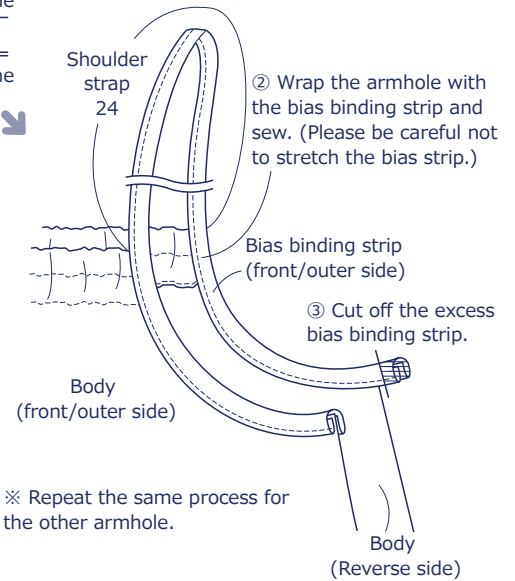
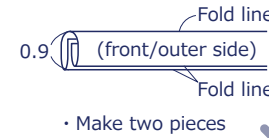

③ Put the elastic tape through (28cm each) and sew the side edge.

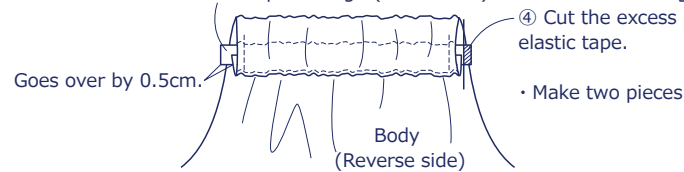

④ Cut the excess elastic tape.

• Make two pieces

3. Sew both side edges.

① With front/outer sides facing each other, sew the side edge. Serge the seam.

② Press the side seam down and run stitches over. (Press the other seam to the opposite side.)

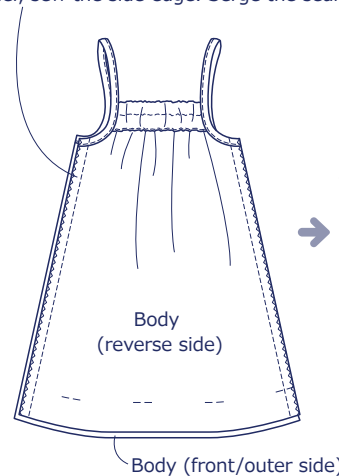

4. Finish the hem.

