



Pumps Shaped Small Case

Design & work created by Yui Tamaki

Size: 8cm (w) 20.5cm (l)

Materials

- Fabric: (Front outer fabric, back fabric) 25cm×30cm
(Lining fabric) 15cm×30cm
(Toe outer fabric) 15cm×10cm
- Coiled fastener (zipper): over 16cm in length – one piece
- Ribbon of your choice

Fabric shown for this sample: P30100-100 (A)

Cutting Layout

All measurements are in centimeters (cm).
All seam allowances 1cm unless otherwise stated.

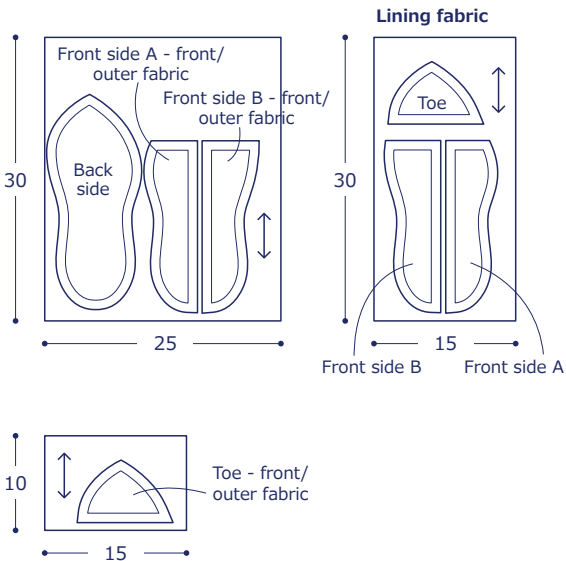

Instructions

1. Attach the zipper to the front side.

① With front/outer sides facing each other, put together the front side A outer fabric and lining fabric. Place the zipper in-between and sew together.

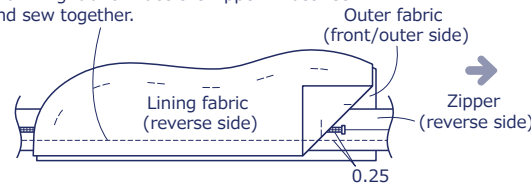

② Turn over ①.

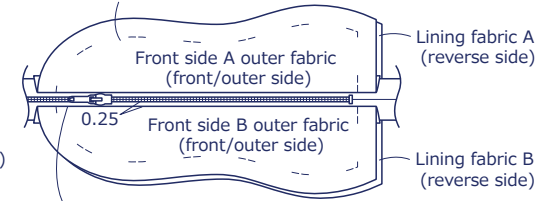

③ With front/outer sides facing each other, put together the front side B outer fabric and lining fabric. Place the zipper in-between and sew together. Turn it over.

2. Make the toe.

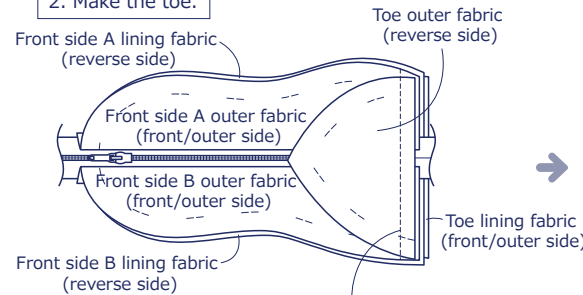

② Turn over the toe.

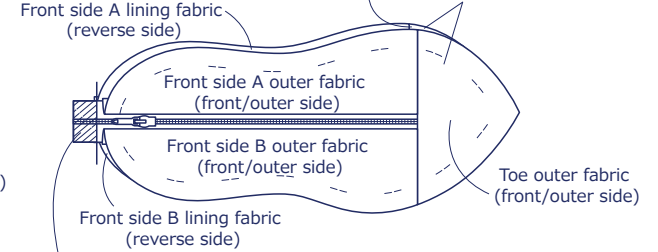

③ Cut the excess zipper. (repeat the process for the toe)

① With front/outer sides facing each other, sew together the toe outer fabric and lining fabric. (Place the main part in between front/outer fabric and lining fabric)

3. Sew together the front and back side.

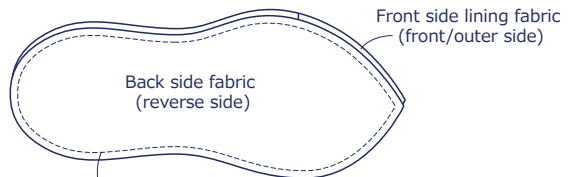
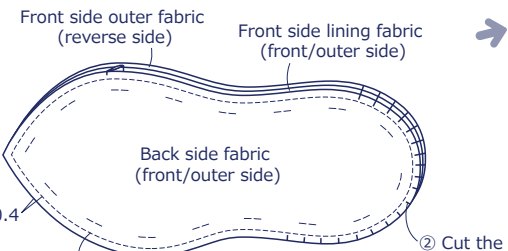

③ Turn it inside out and sew along the finished line. (leave the zipper open)

① As shown, put together the front side and back side. Run stitches outside the finished line. (leave the zipper open)

4. Attach the ribbon.

① Turn it inside out and align the shape.

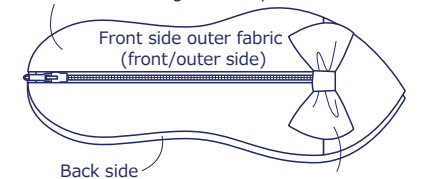

② Attach the ribbon.

Add 1cm seam when cutting the fabric (refer to the cutting layout)

Lining fabric and back side are cut symmetrically.

