



Dress for a Grown-Up

Design & work: Kokka Fabric

Size: 112cm chest x 90cm dress length

have fun with KOKKA fabric! produced by **KOKKA**

kokka-fabric.com

Materials

□ Outer Fabric: 110cm (width) × 220cm

Fabric shown for this sample: Irome HFG107-3 (B)

Pattern and Cutting Layout

All measurements are in centimeters (cm).
Numbers in () denote seam allowance.
All seam allowances 1cm unless otherwise stated.

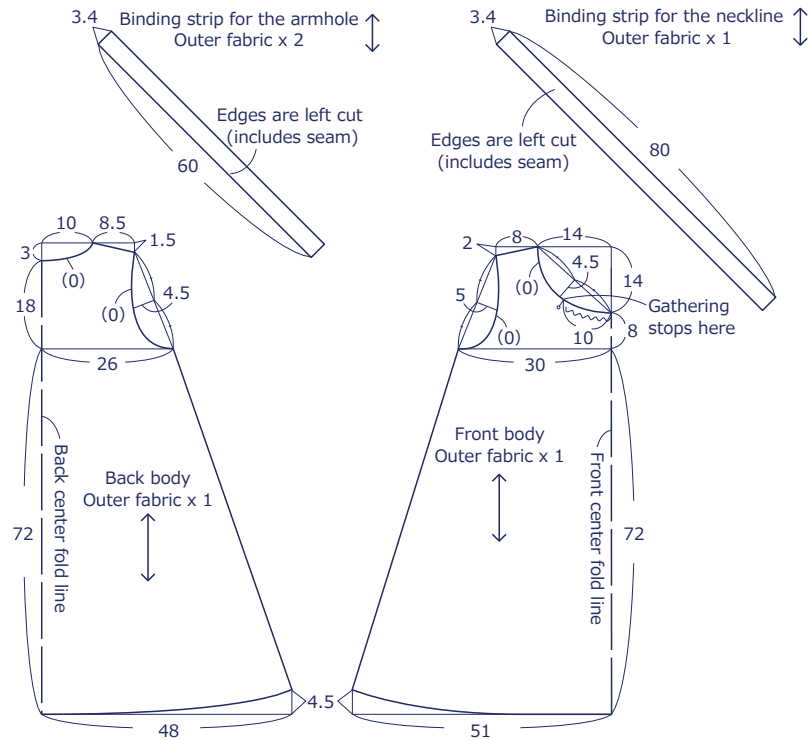

Instructions

1. With front sides facing each other, sew together the front and back bodies at the shoulder.

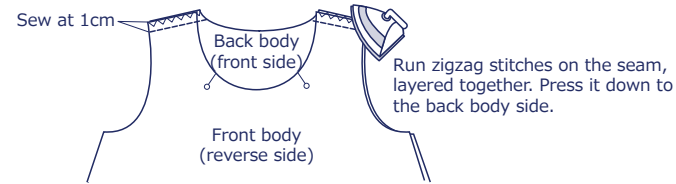

2. Run rough stitches on the front neckline. Shrink it to 12cm to make a gathering.

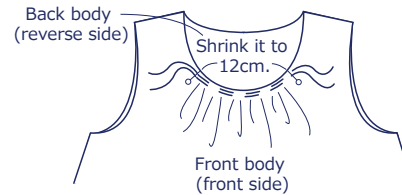

3. Wrap the neckline with binding strip and sew.

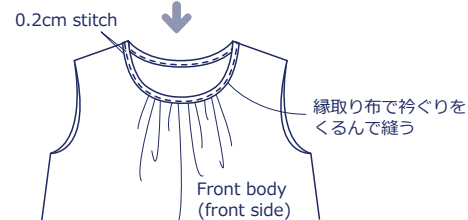
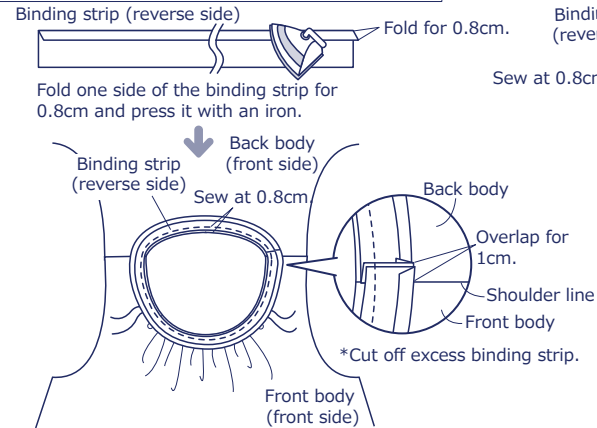

4. With front sides facing each other, sew together the front and back bodies at sides.

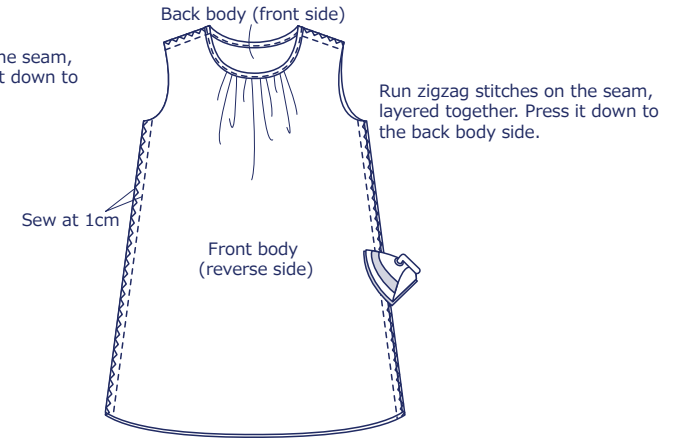

5. Wrap the armhole with binding strip and sew.

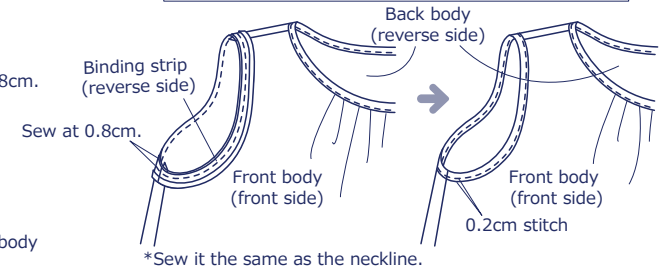

6. Double fold the hem and run stitches to finish.

