



# Pleated Tote

Design & work: Kokka Fabric

Size: about 20cm (l) x about 28cm (w) x about 8cm (d) (not including handles and pockets)

The craft projects and works featured in kokka-fabric.com are strictly for personal use and enjoyment. Please refrain from selling handmade items using the same exact design (including the pieces made in different fabrics) featured in kokka-fabric.com.

## Materials

- Outer fabric: 70cm x 108cm wide
- Lining fabric: 40cm x 110cm wide
- Fusible quilt batting: 75cm x 90cm wide

Fabric shown for this sample: H10000-100 (C)

## Pattern

All measurements are in centimeters (cm). The edges are left cut.

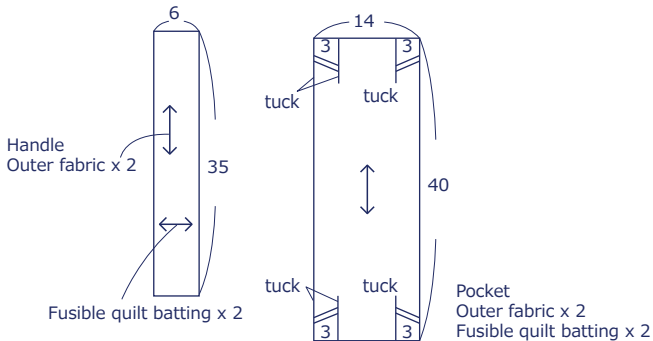
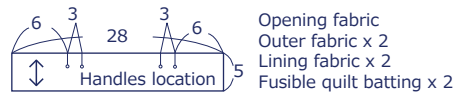
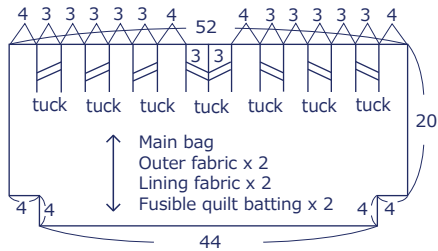

\*Adhere fusible quilt batting on the back of the outer fabric.

## Instructions

1. Make the handles per finished measurement. Baste them to the main bag outer fabric.

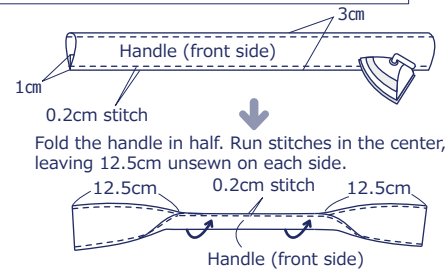

2. Add tucks on the main bag fabric.

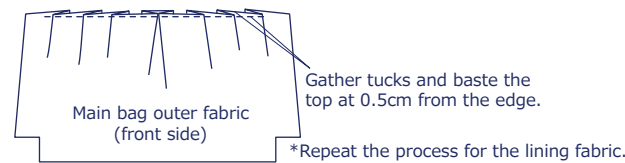

3. With the front sides facing each other, sew together the main outer bag fabric at the sides, bottom and gusset.

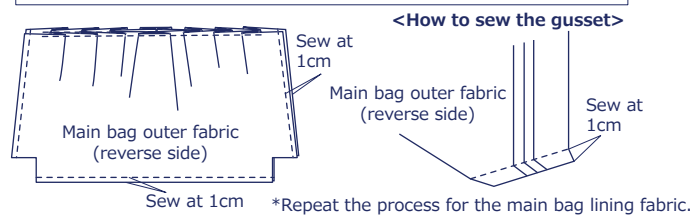

4. Make the pockets and attach them to the main bag outer fabric.

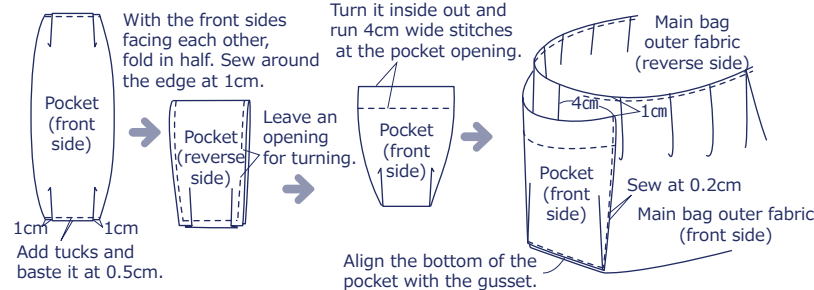

5. With the front sides facing outside, baste the main bag outer fabric and lining fabric at the opening at 0.5cm from the top edge.

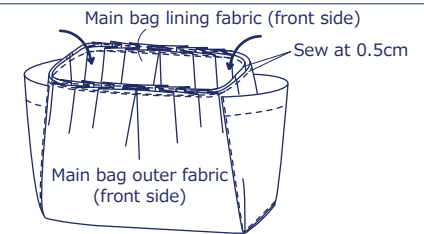

6. With the front sides facing each other, put together the opening fabric with handles in-between and sew together.

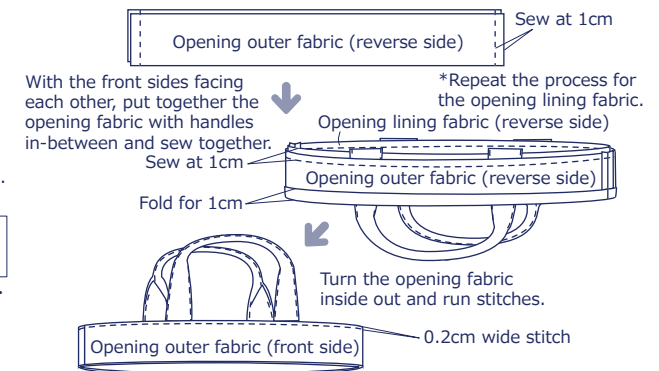

7. With the front sides facing each other, sew together the opening fabric and main bag.

