



Throw Pillow Cover

Design & work: Yui Tamaki

Size: 45cm × 45cm

have fun with KOKKA fabric! produced by **KOKKA**

kokka-fabric.com

The craft projects and works featured in kokka-fabric.com are strictly for personal use and enjoyment.
Please refrain from selling handmade items using the same exact design (including the pieces made in different fabrics) featured in kokka-fabric.com.

Materials

- Fabric (Front side a, Back side): 90cm×50cm
(Front side b (#11 Canvas)): 20cm×50cm
(Frill (Thin artificial leather): 70cm×10cm
- Zipper: One piece (40cm long)

Fabric shown for this sample: P44500-500 (D)

Pattern and Cutting Layout

All measurements are in centimeters (cm). Add 1.5cm seam unless otherwise specified.

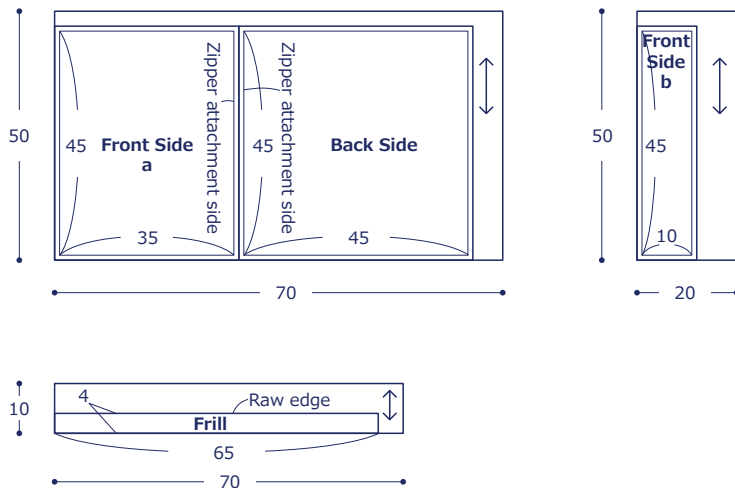

Instructions

① Apply rough stitches on the frill. Pull the thread to make the length to 45cm.

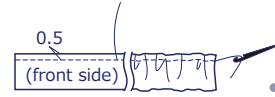

② Baste the frill on the Front side b.

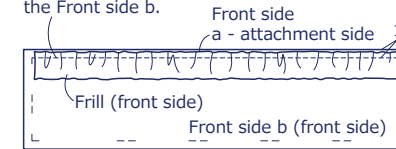

③ With the front sides facing each other, sew together the front side a and b. Apply zigzag stitches on the seam.

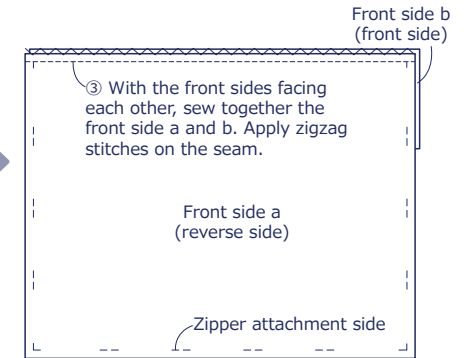

④ Apply zigzag stitches on the seam of the zipper attachment side of both front and back sides.

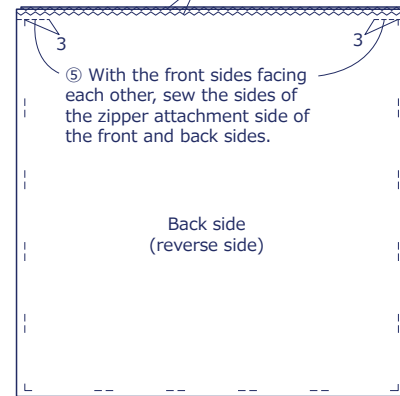

⑤ With the front sides facing each other, sew the sides of the zipper attachment side of the front and back sides.

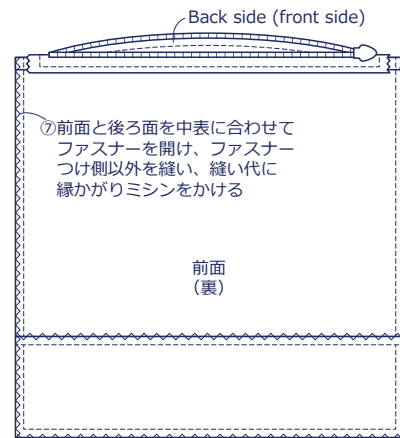
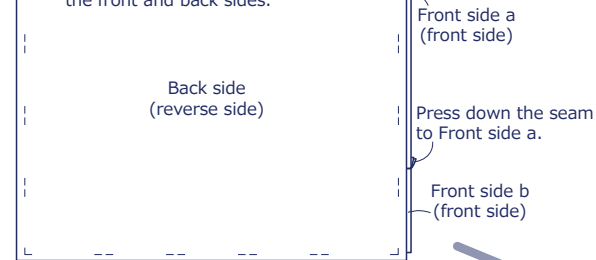

⑧表に戻す

