



Boater Hat

Design & Work: Anriko

Size: 60cm (head circumference,
actual size is smaller due to interlining)
7cm (height)

Materials

- Fabric (Outer fabric, Brim lining fabric): 110cm×50cm
(Side crown lining fabric, Top crown lining fabric) : 90cm×30cm
- Fusible interfacing (Medium-weight): 70cm×50cm
(Heavyweight): 30cm×30cm
- Stay tape: 1m (width 1cm)
- Grosgrain ribbon: 1.4m (width 2.5cm)

Fabric shown for this sample:

(Outer fabric, Brim lining fabric)PAINT by ellen baker JG42010-11A

Pattern and Cutting Layout

Unit: Centimeters (cm) Add 1cm seam allowance.

Outer fabric - Rough cutting first. Adhere interfacing on the back and cut to shape.

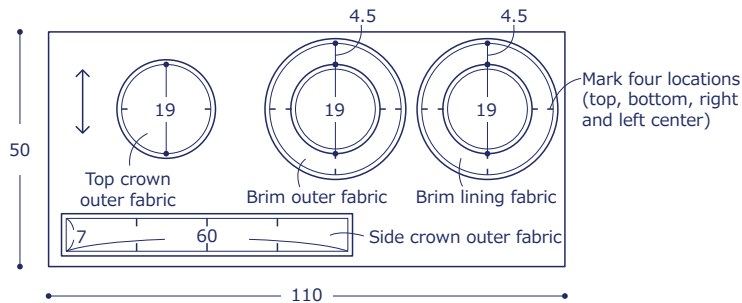

Top crown outer fabric and Side crown outer fabric - Adhere medium-weight interfacing
Brim outer fabric - Adhere heavyweight interfacing
Brim lining fabric - Adhere stay tape around perimeter

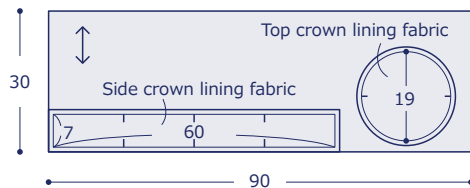

have fun with KOKKA fabric! produced by **KOKKA**

kokka-fabric.com

The craft projects and works featured in kokka-fabric.com are strictly for personal use and enjoyment.
Please refrain from selling handmade items using the same exact design (including the pieces made in different fabrics) featured in kokka-fabric.com.

Instructions

1. Make the crown.

② With the front sides facing each other, sew together the top crown outer fabric and side crown outer fabric. Press the seam open and apply stitches.

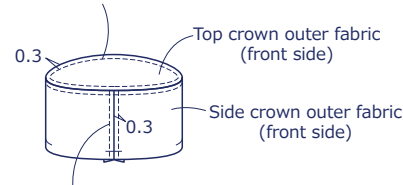

① With the front sides facing each other, sew together the short ends of the side crown outer fabric. Press the seam open and apply stitches.

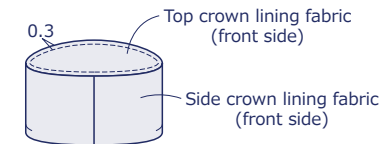

③ As in ① and ②, sew together the lining fabrics. (No stitches on the side crown)

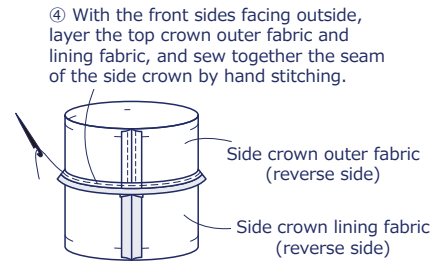

④ With the front sides facing outside, layer the top crown outer fabric and lining fabric, and sew together the seam of the side crown by hand stitching.

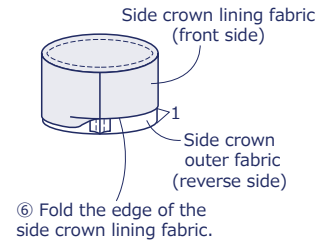

⑥ Fold the edge of the side crown lining fabric.

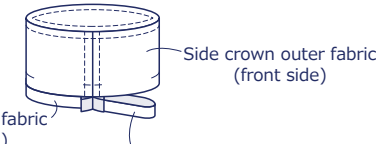

⑤ Turn it over. Align the shape and cut off the excess from the side crown lining fabric.

2. Make the brim and finish the hat.

① With the front sides facing each other, sew together the perimeter of the brim outer fabric and lining fabric.

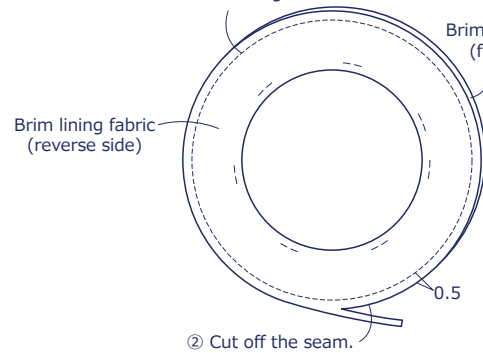

② Cut off the seam.

④ With front sides facing each other, sew together the side crown outer fabric and brim. Press the seam down to the side crown side and apply stitches.

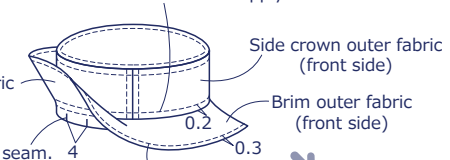

⑤ Cut a slit on the seam.

③ Turn over the brim and apply stitches.

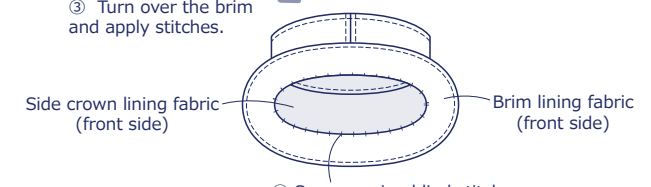

⑥ Sew up using blind stitches.

⑦ Tie the ribbon.