



Smock

Design & Work: Kokka Fabric

Size: 110cm

have fun with KOKKA fabric! produced by KOKKA

kokka-fabric.com

The craft projects and works featured in kokka-fabric.com are strictly for personal use and enjoyment. Please refrain from selling handmade items using the same exact design (including the pieces made in different fabrics) featured in kokka-fabric.com.

Materials and Tools

- Fabric A: about 108cm wide x 100cm
- Fabric B: about 110cm wide x 20cm
- Fabric C: about 110cm wide x 20cm
- Bias binding tape: about 11mm wide x 70cm
- Elastic tape: about 8mm wide x 75cm

Fabric shown for this sample: (Fabric A) YKA-59000-2A

Pattern

Unit: cm []: Seam allowance

Add 1cm seam allowance unless specified otherwise.

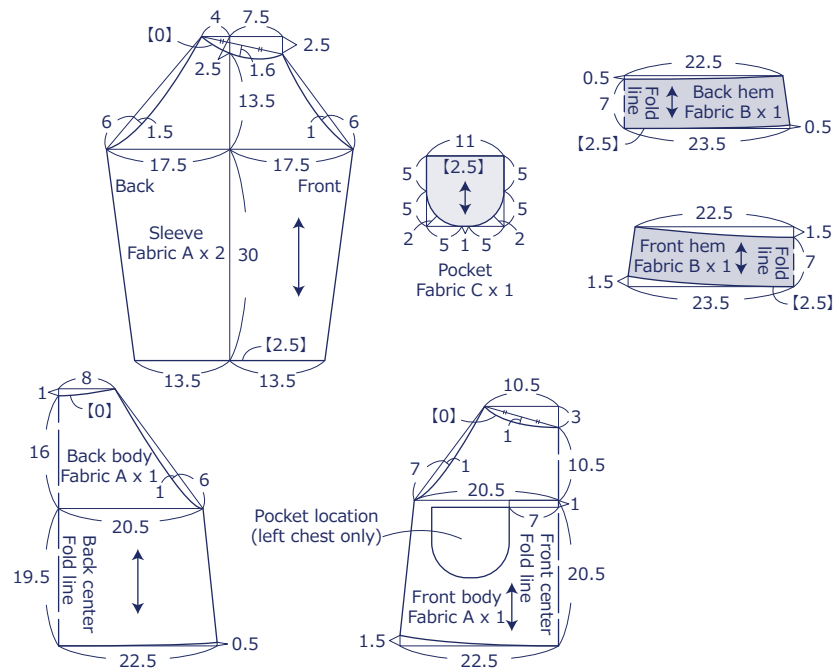

Instructions

1. Make the pocket and attach it to the front body

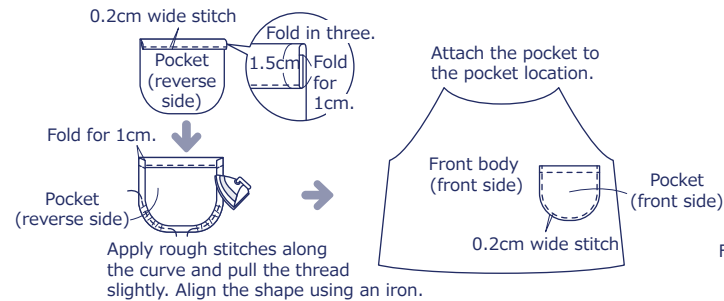

2. With the front sides facing each other, sew together the body and hem

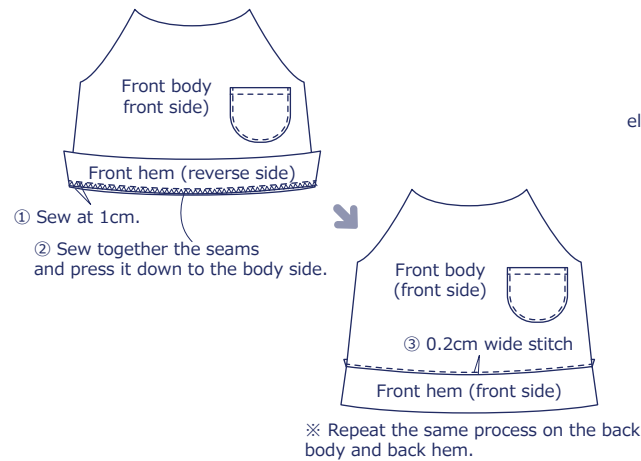

3. With the front sides facing each other, sew together the body and sleeve

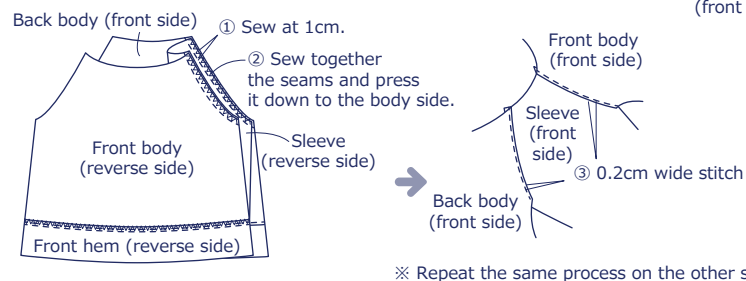

4. With the front sides facing each other, sew together the bodies at the sides

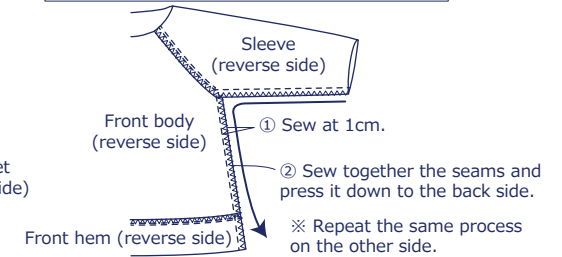

5. Finish the cuff and put through the elastic tape

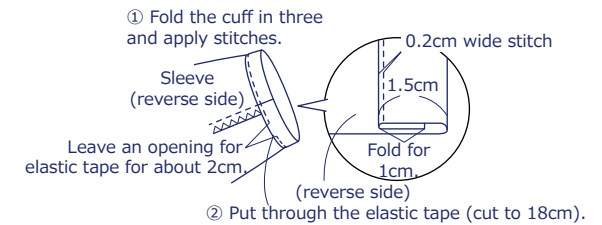

6. Fold the hem in three and apply stitches

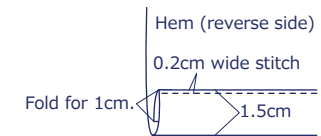

7. Finish the neckline using the bias binding tape. Put through the elastic tape to finish

