



# Body Bag

Design & work: Kokka Fabric

Size: about 28cm (l)  
about 20cm (w)  
about 10cm (d)

## Materials

- Outer Fabric: 110cm wide × 50cm
- Lining Fabric: 110cm wide × 50cm
- Fusible interfacing (medium weight): 90cm wide × 50cm
- Zipper: 30cm x 1
- Flat tape: 25mm wide × 50cm
- Square ring: 25mm wide x 1
- Rectangle buckle: 25mm wide x 1

Fabric shown for this sample: LGA-19030-2A

## Pattern & Cutting Layout

Unit: cm.

When cutting the fabric, add 1cm seam allowance.

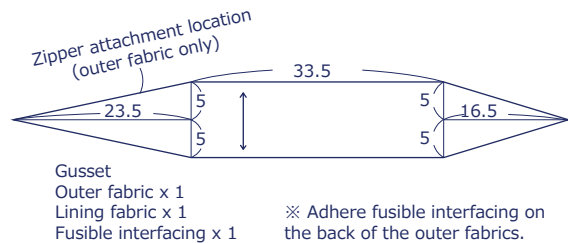
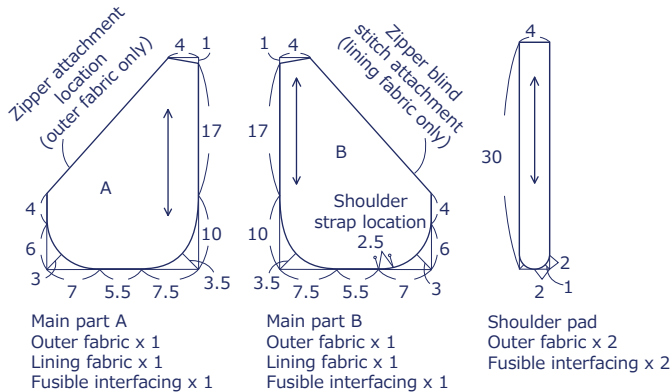

have fun with KOKKA fabric! produced by KOKKA

[kokka-fabric.com](http://kokka-fabric.com)

The craft projects and works featured in kokka-fabric.com are strictly for personal use and enjoyment. Please refrain from selling handmade items using the same exact design (including the pieces made in different fabrics) featured in kokka-fabric.com.

## Instructions

### 1. Make the shoulder strap and baste it to the Main part B outer fabric

Put through the flat tape in the middle of the rectangle buckle. Fold in three and sew to secure.

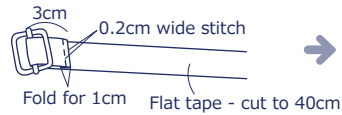

Put through the unsewn end of the flat tape to the square ring first, then put it through the rectangle buckle.

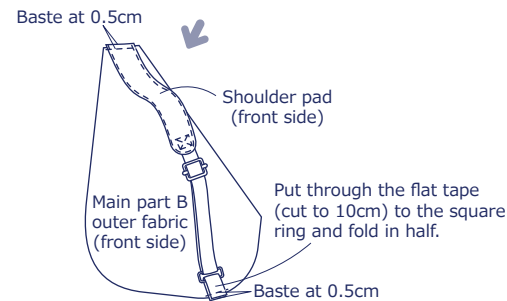
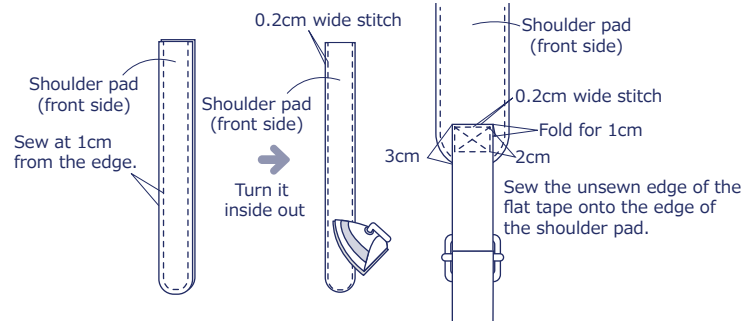

### 2. Attach the zipper to the Main part A outer fabric and gusset

Fold the seam of the zipper attachment side. Layer it over the zipper and sew.

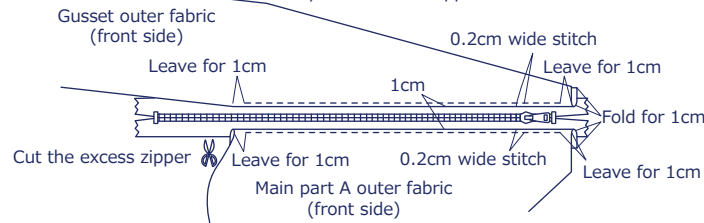

### 3. With the front sides facing each other, sew together the main part and gusset

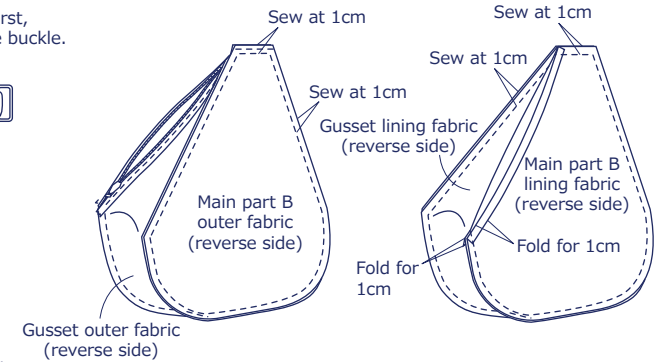

### 4. With the front sides facing outside, put together the outer fabric and lining fabric at the opening using blind stitches

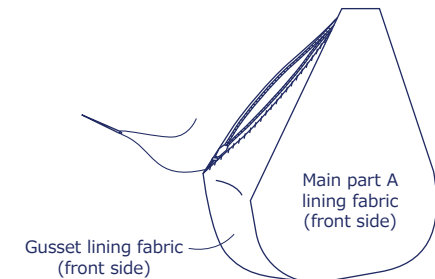

### 5. Turn it inside out using the zipper opening. Align the shape to finish

