



Dress with Frills

Design & work: Kokka Fabric

Size: 100

Materials

- Fabric: Double Gauze 108cm wide x 170cm
 - Button: One piece (11.5mm wide)
- Fabric shown for this sample: YK-61150-2A

Pattern

○ denotes seam allowance. Add seam allowance when cutting the fabric.

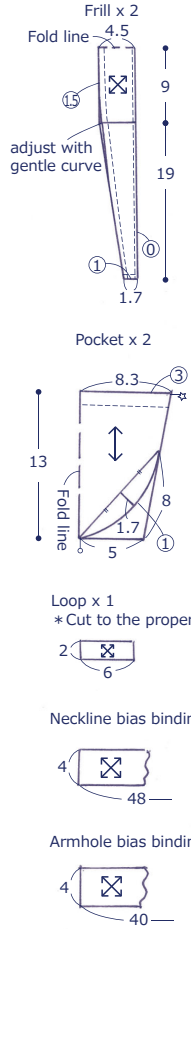
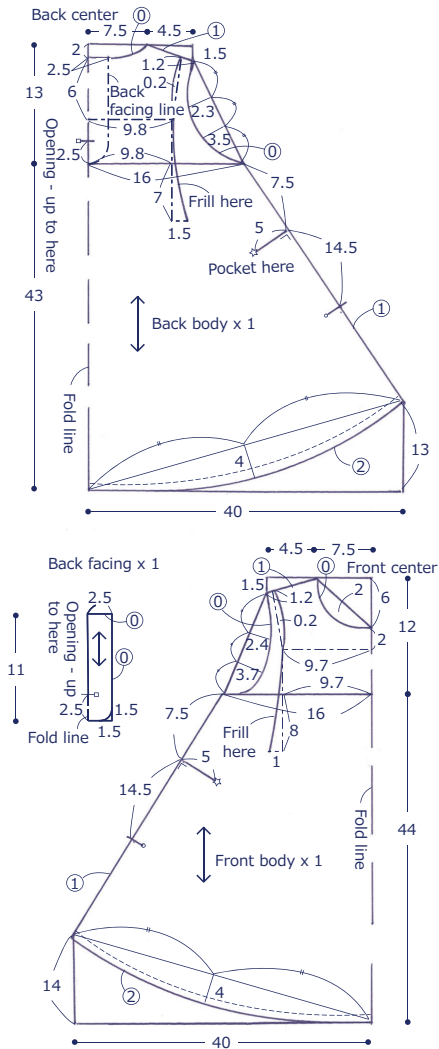

作り方

3. Create an opening in the back center

- ① Layer the back facing over the back body and sew up to where opening stops.
- ② Cut a slit up to where the opening stops.
- ③ Turn over the facing to the back side and run stitches.

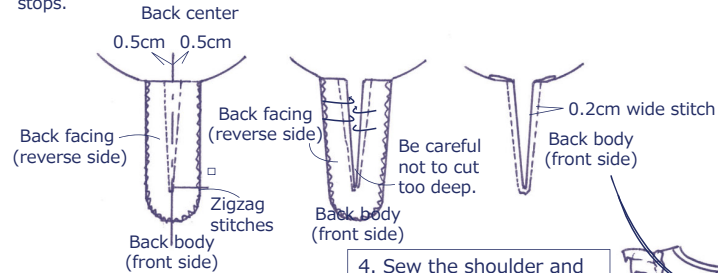

5. Attach the bias binding tape around the neckline. Place the loop in-between and finish the neckline

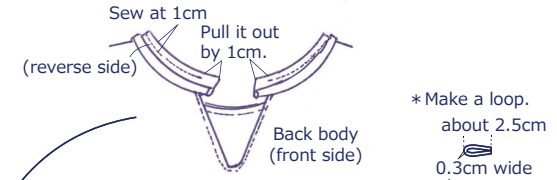

4. Sew the shoulder and finish with zigzag stitches on the seam

6. Attach the bias binding tape around the armhole

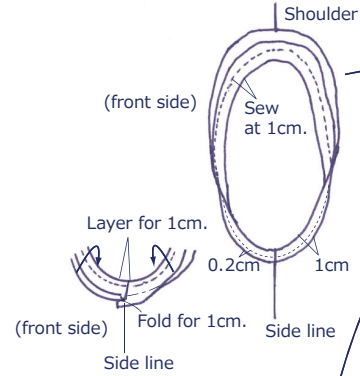

1. Sew the sides of the front and back. Finish with zigzag stitches on the seam

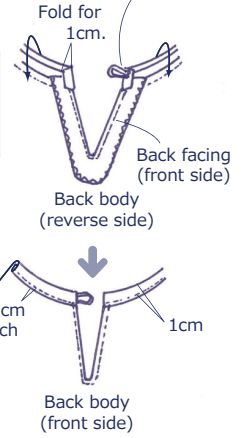

2. Attach the pockets on the sides

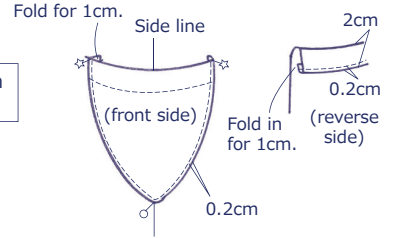

7. Attach the frills

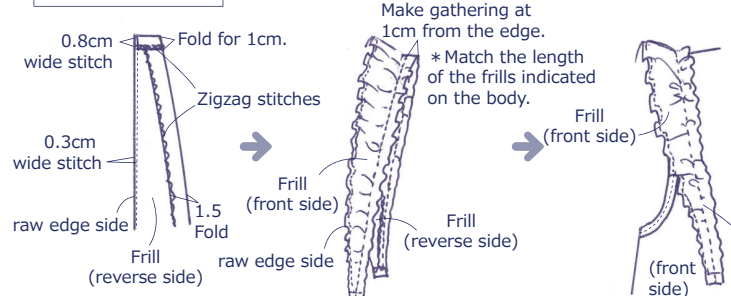

8. Fold the hem in three and finish

