



Shoulder Bag with Frills

Design & work: Yui Tamaki

Size: 19cm (l) 40cm (w-opening side)

Materials & Tools

- Fabric (Outer fabric, Pocket, Frill, Shoulder strap): 110cm wide×70cm
(Lining fabric, Zipper tab fabric): 110cm×30cm
- Fusible interfacing (heavy weight) 90cm×25cm
- Double slide zipper: One piece (length 40cm)
- Tag: One piece

Fabric shown for this sample:

(Outer fabric, Pocket, Frill, Shoulder Strap) echino EKK-97030-32E
(Lining fabric, Zipper tab fabric) echino solid JG-95410-10K

Pattern

Unit: Centimeters (cm)

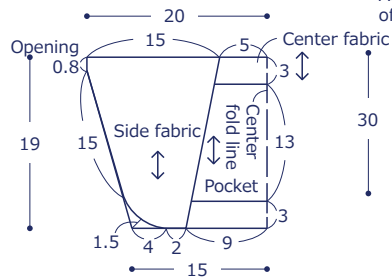

Cutting Layout

Add 1cm seam allowance unless otherwise stated.
Adhere fusible interfacing on the back of the lining fabric.

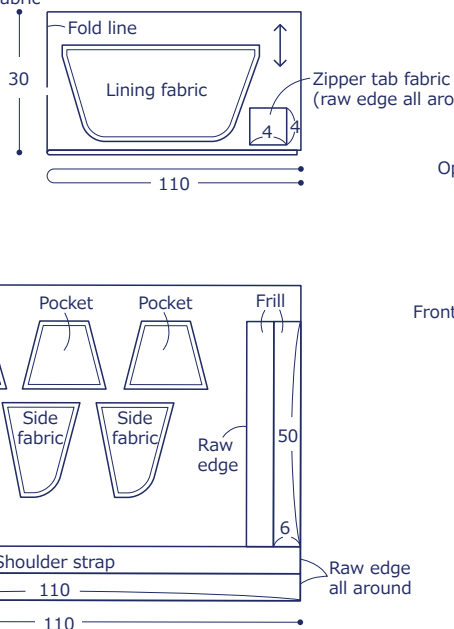

Instructions Front Side - (FrS), Reverse Side (RvS)

1. Make the front outer fabric

① Fold one of the long ends of the frill fabric in three and sew.

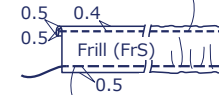

② Sew with rough stitches.
③ Pull the thread from ② to shrink to the specified dimension.
• Make two pieces.

⑤ Baste the frill on the center fabric.

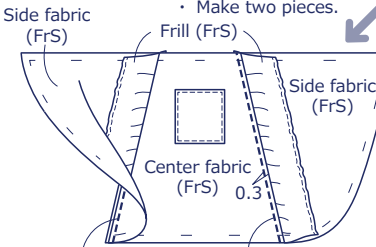
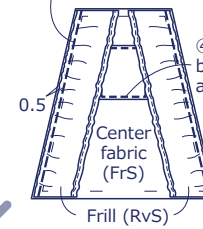

2. Make the back outer fabric

① With the front sides facing each other, sew the top and bottom end of the pocket fabrics.

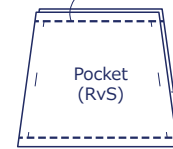

③ Baste both ends.

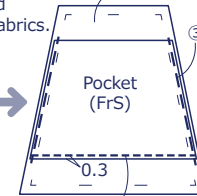

④ As in ①⑥, attach the side fabric (No tag or frills). Press down the seam to the side fabric side and apply stitches.
② Turn the pocket inside out. Place it over the center fabric and sew the bottom end.

3. Attach the zipper

① Baste the zipper to the lining fabric.



② With the front sides facing each other, sew together the ① and front outer fabric at the top opening side.

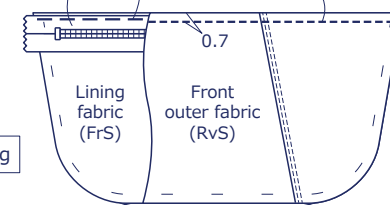

③ As in ①②, attach the other side of the zipper to the lining fabric and back side of the outer fabric.

4. Make the outer bag and lining bag

⑥ With the front sides facing each other, sew together the piece from ⑤ and side fabric.
⑦ Press down the seam to the center fabric and apply stitches.

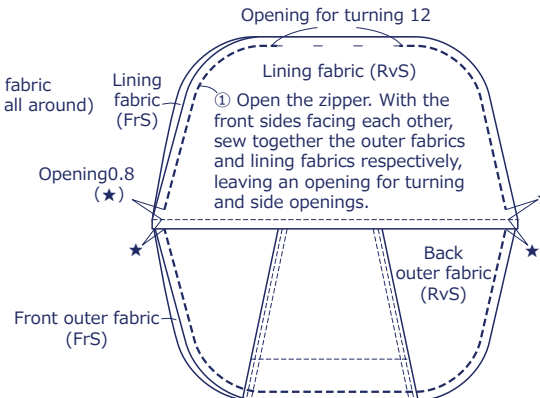

5. Make the shoulder strap

① With the front sides facing each other, sew two pieces together.

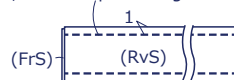

② Turn it inside out and fold both ends in three.



6. Finish the bag

