



Tote Bag with Transition

Design & Work: Kokka Fabric

Size: about 22cm (l) about 35cm (w)
about 10cm (gusset)
(Handles excluded)

Materials

- Outer fabric A(Print): about 110cm wide x 50cm
- Outer fabric B(Solid): about 110cm wide x 30cm
- Lining fabric (Solid): about 110cm wide x 50cm
- Fusible interfacing (heavy weight): about 110cm wide x 60cm
- Dot button: about 15mm wide x 1 pai

Outer fabric A: TOTE WORLD YK-66120-1B
Outer fabric B: Solid YK1034-1F
Lining fabric: Solid YK-1033-1G

Pattern and Cutting Layout

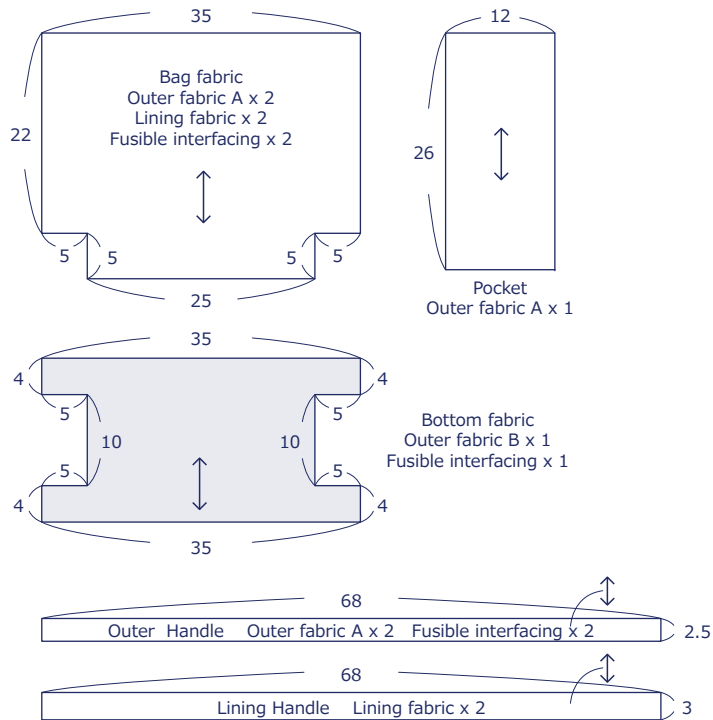

※ Adhere fusible interfacing on the back of the outer bag fabric, bottom fabric and outer handle.

have fun with KOKKA fabric! produced by KOKKA

kokka-fabric.com

The craft projects and works featured in kokka-fabric.com are strictly for personal use and enjoyment. Please refrain from selling handmade items using the same exact design (including the pieces made in different fabrics) featured in kokka-fabric.com.

Instructions Front Side - (FrS), Reverse Side (RvS)

1. Make the pocket

With the front sides facing outside, fold the pocket opening in half and apply stitches.



2. Make the handle

Fold the seam of the handle.

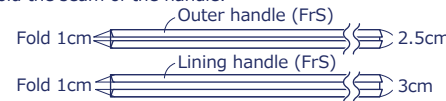

Layer the outer handle and lining handle and apply stitches.

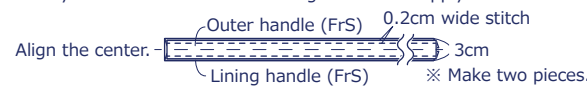

3. Baste the pocket to outer bag fabric. Attach the handles

Attach the handles.

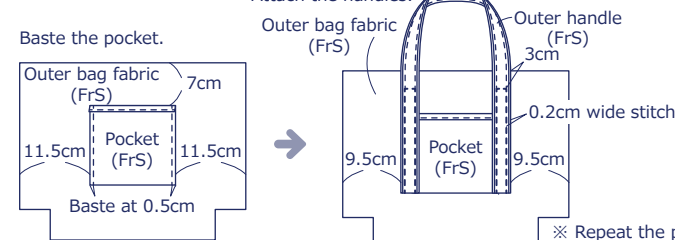

4. Sew together the bottom fabric and outer bag fabric

With the front sides facing each other, sew the bottom of the outer bag fabric.

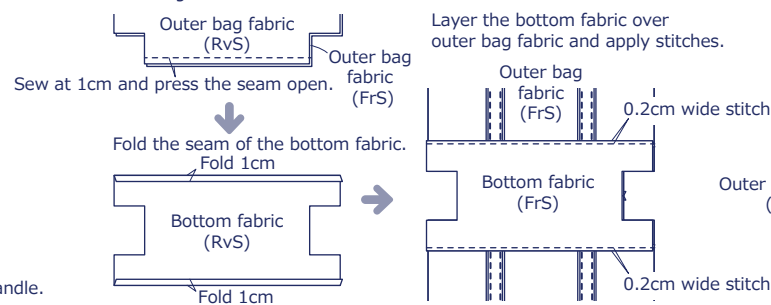

5. With the front sides facing each other, sew together the bag fabrics at the sides

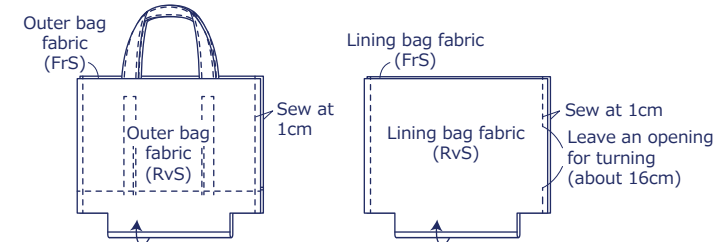

6. Sew the gusset

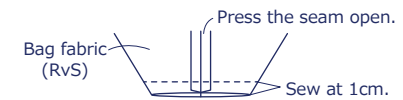

7. With the front sides facing each other, sew together the bags at the top opening

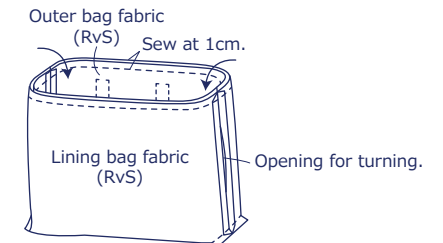

8. Turn it inside out and apply stitches at the bag opening. Attach the dot button to finish.

