



# Big Tote Bag

Design & Work: Kokka Fabric

Size: about 30cm (l)  
 about 50cm (w)  
 about 16cm  
 (Excludes handles)

## Materials

- Outer Fabric (solid): about 110cm wide × 100cm
- Lining Fabric (solid): about 110cm wide × 100cm
- Fusible interfacing (heavy weight) about 110cm wide × 100cm
- Dot Button: about 15mm wide × One pair

Fabric shown for this sample: YP-11530-2C

## Pattern and Cutting Layout

Unit: Centimeters (cm) Add 1cm seam when cutting the fabric.

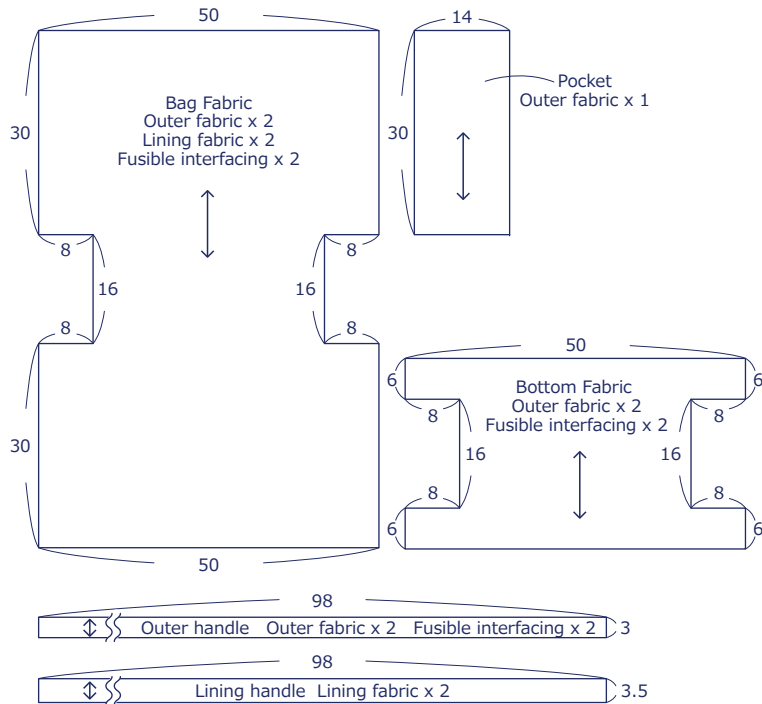

※ Adhere fusible interfacing on the back of the bag outer fabric, bottom fabric and outer handle fabric.

have fun with KOKKA fabric! produced by KOKKA

[kokka-fabric.com](http://kokka-fabric.com)

The craft projects and works featured in kokka-fabric.com are strictly for personal use and enjoyment. Please refrain from selling handmade items using the same exact design (including the pieces made in different fabrics) featured in kokka-fabric.com.

## Instructions Front Side - (FrS), Reverse Side (RvS)

### 1. Make the pocket

With the front sides facing outside, fold the pocket in half.



Fold the pocket opening in half and apply stitches.

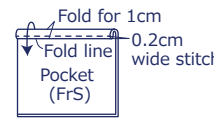

### 2. Make the handles

Fold the seam of the handle.

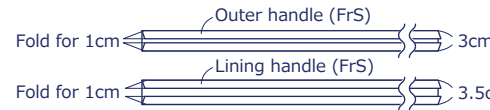

Layer the outer and lining handles and apply stitches.

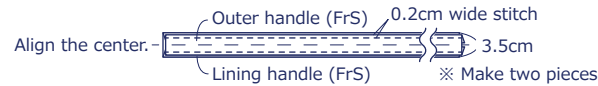

### 3. Baste the pocket on the outer bag fabric. Attach handles

Baste the pocket.

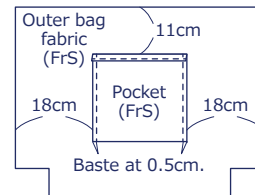

Attach the handle.

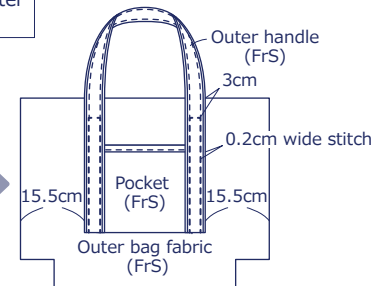

※ Repeat the process for another set.

### 4. Sew together the outer bag fabric and bottom fabric

Fold the seam of the bottom fabric.

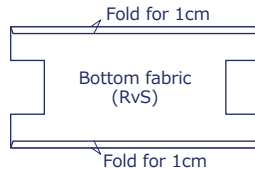

Layer the bottom fabric over the outer bag fabric and apply stitches.

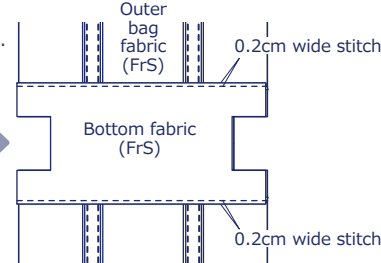

### 5. With the front sides facing each other, sew together the side of the bag fabrics.

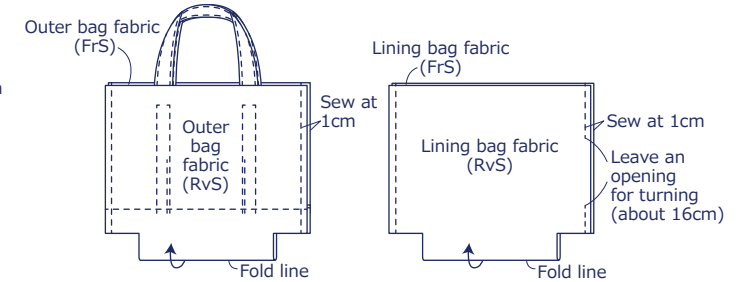

### 6. Sew the gusset

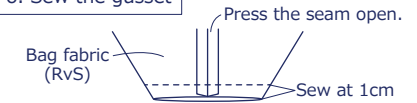

### 7. With the front sides facing each other, sew together the bag fabrics at the top opening

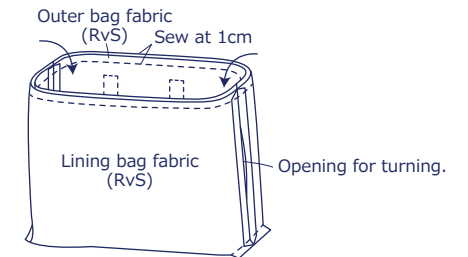

### 8. Turn the bag inside out. Apply stitches around the top opening and attach the dot button to complete

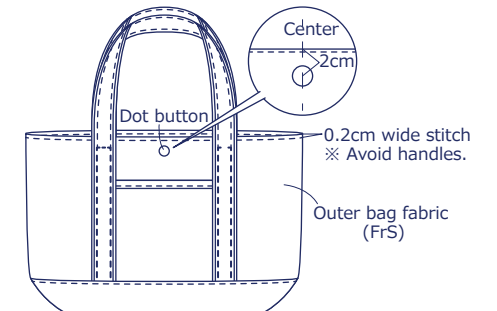

※ Close the opening for turning.