



Easy-To-Fold Reusable Bag (Eco Bag)

Design & work: Satomi Takei

Size: (When folded) 18cm (l) 55cm (w)

have fun with KOKKA fabric! produced by KOKKA

kokka-fabric.com

The craft projects and works featured in kokka-fabric.com are strictly for personal use and enjoyment. Please refrain from selling handmade items using the same exact design (including the pieces made in different fabrics) featured in kokka-fabric.com.

Materials

- Fabric: 110cm wide x 50cm
- Twilled tape: 2.5cm wide x 1.2m
- Elastic tape: 1cm wide x 23cm

Fabric shown for this sample: echini patterns tankan EKX-97080-81B

Pattern and Cutting Layout

Unit: Centimeters (cm) All raw edge

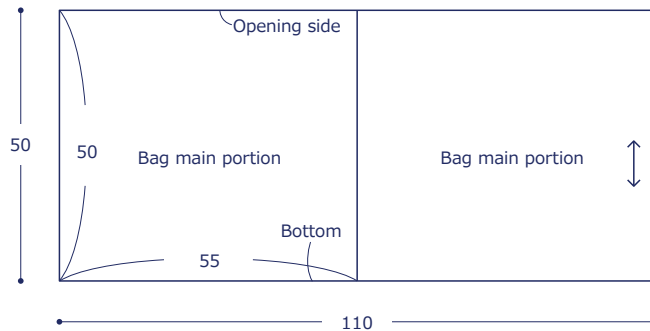

Instructions Front Side - (FrS), Reverse Side (RvS)

1. Sew the bottom

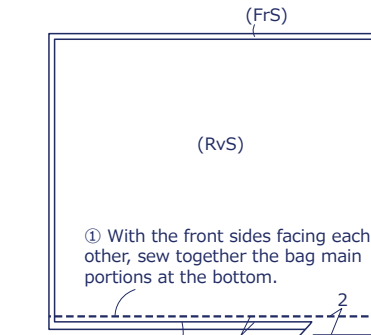

② Cut the seam of one of the fabrics.



③ With the front sides facing each other, sew the uncut seam in half. Wrap the other seam around and sew.

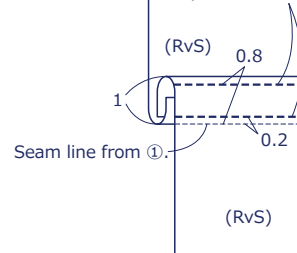

2. Fold and attach the handles

① Fold the edge at the top opening in three and apply stitches.

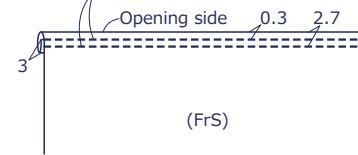

• Repeat the process on the other side.

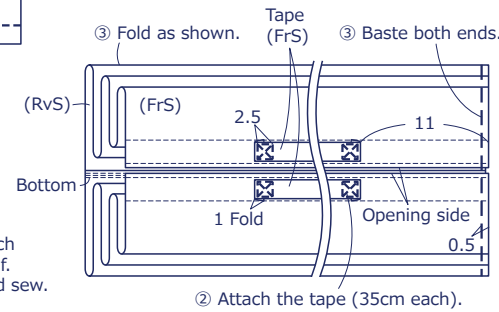

② Attach the tape (35cm each).

3. Finish the side ends

① Fold the tape (6cm each) in half and baste.

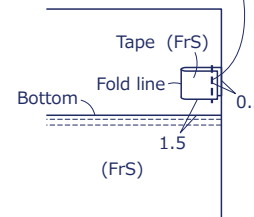

② Fold the tape (21cm each) in half. Place the ends in-between and apply stitches.

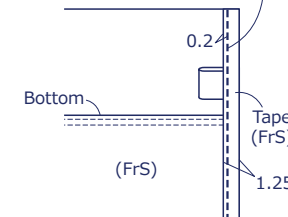

Fold the end by 1.5cm.

③ Insert the elastic and sew.

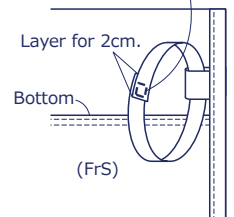

How to fold the bag

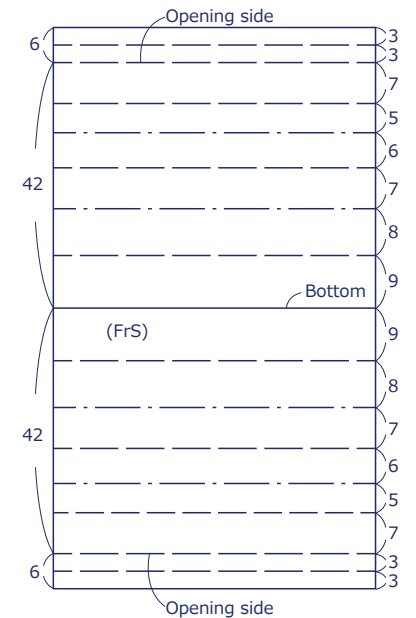

--- = Mountain fold
- - - = Valley fold