

The craft projects and works featured in kokka-fabric.com are strictly for personal use and enjoyment. Please refrain from selling handmade items using the same exact design (including the pieces made in different fabrics) featured in kokka-fabric.com.

Ribbon Tote Bag



Design & work: Mioko Sugino

Size: 22cm (l)
38cm (w-opening side)
24cm (bottom)
14cm (d)

Materials

- Fabric (Outer Fabric-Top): 80cm x 20cm
(Outer Fabric-Bottom, Handle, Lining Fabric (#9.5 Canvas)): 100cm x 60cm
(Ribbon Fabric): 50cm x 50cm

Fabric shown for this sample:

- (Outer Fabric-Top) EKK-97200-201C
- (Outer Fabric-Bottom, Handle, Lining Fabric (#9.5 Canvas)) YK-530-11
- (Ribbon Fabric) echino solid JG-95410-10C

Pattern and Cutting Layout

Unit: cm. 1cm seam allowance unless otherwise specified.

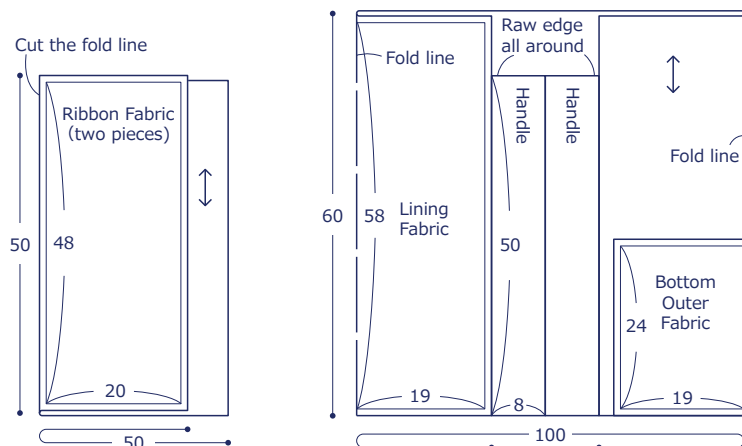
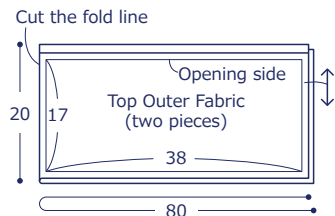

Instructions

Front Side - (FrS), Reverse Side (RvS)

1. Make the ribbon

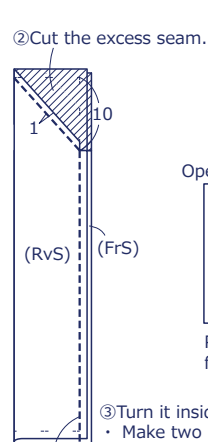

2. Attach the ribbon

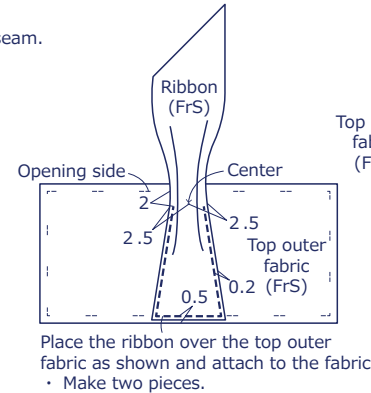

3. Make the outer bag

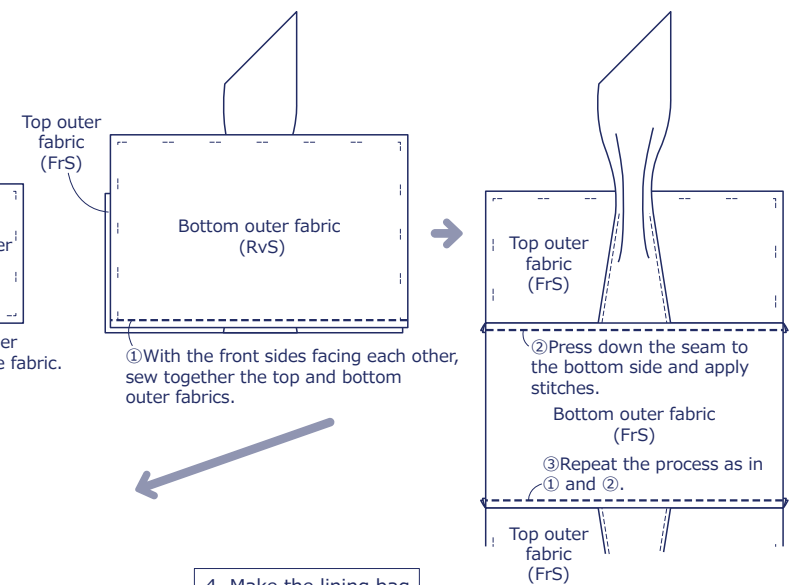

①With the front sides facing each other, fold the ribbon fabric in half and sew as shown.

④With the front sides facing each other, fold in half and sew both sides.

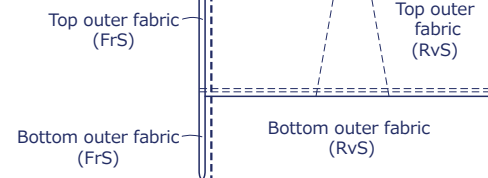

⑤Fold the bottom corner into a triangle and sew the gusset.

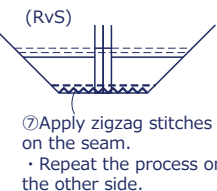
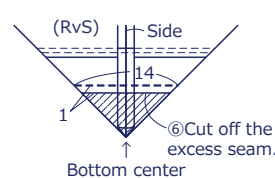

4. Make the lining bag

Using the lining fabric, repeat the process as in ③④~⑦ to make the lining bag.

5. Make the handle to finish

