



# Round Micro Mini Bag

Design & work: Yui Tamaki

Size: 15cm (l) 15cm (w) 6cm (d)

have fun with KOKKA fabric! produced by KOKKA

[kokka-fabric.com](http://kokka-fabric.com)

The craft projects and works featured in kokka-fabric.com are strictly for personal use and enjoyment. Please refrain from selling handmade items using the same exact design (including the pieces made in different fabrics) featured in kokka-fabric.com.

## Materials

- Fabric (Panel Outer Fabric): 34cm×17cm  
(Gusset Outer Fabric): 30cm×20cm  
(Lining Fabric): 34cm×35cm
- Quilt Batting: 34cm×17cm
- Felt Style Fusible Interfacing: 34cm×35cm
- Cotton Tape: 2cm wide x 1.2m
- Handle: 1.5cm wide x 30cm – One Pair
- Zipper: 20cm – One Piece
- Rivet: Large (about 0.9cm diameter) - Four Pairs

Fabric shown for this sample: EGX-7702-5B

## Pattern and Cutting Layout

Unit: cm All raw edge  
Adhere fusible interfacing on the back of the lining fabrics.

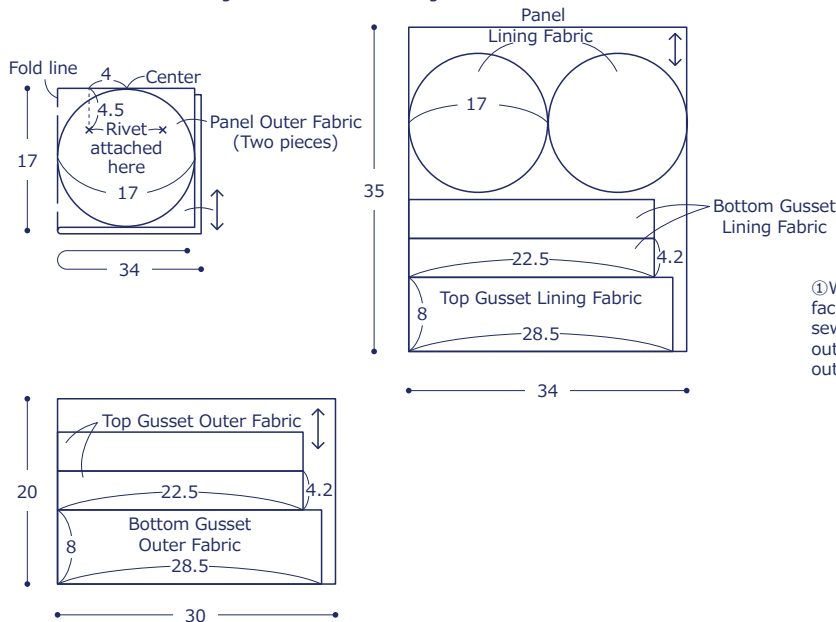

## Instructions Front Side - (FrS), Reverse Side (RvS)

### 1. Make the side pane

With the front sides facing outside, put together and baste the outer and lining fabrics with the quilt batting in-between.

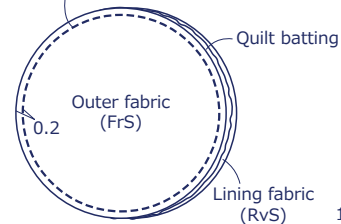

• Make two pieces.

### 2. Make the gusset

- ① Make the top gusset.
- ② With the front sides facing each other, sew together the top gusset outer and lining fabrics with a zipper placed in-between.

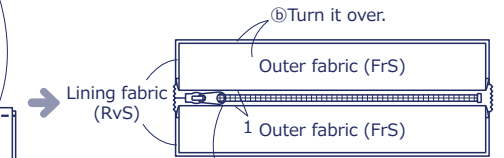
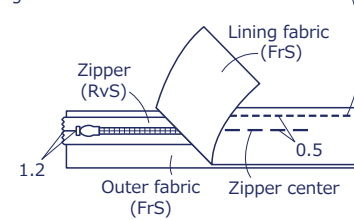

③ Repeat the process on the other side by repeating steps ② and ③.

- ② With the front sides facing each other, sew together the bottom gusset outer and lining fabrics with a piece from ① placed in-between.

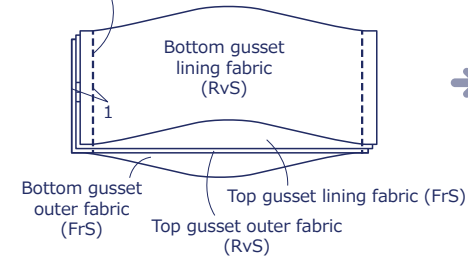

- ③ Turn over the piece from ② and align the shape.

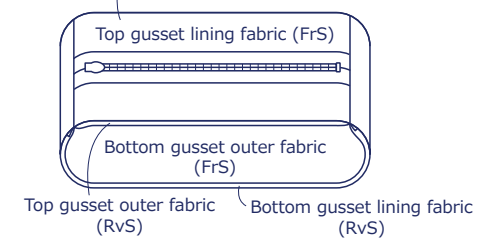

### 3. Finish the bag

- ① With the front sides facing each other, sew together the panel outer fabric and gusset outer fabric.

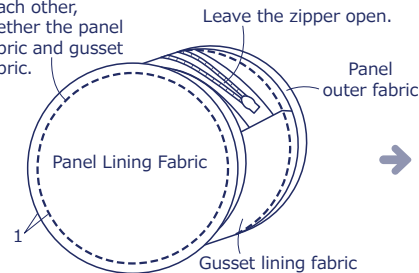

- ② Fold the tape in half. Wrap the seam from ① with the tape and attach using blind stitches.

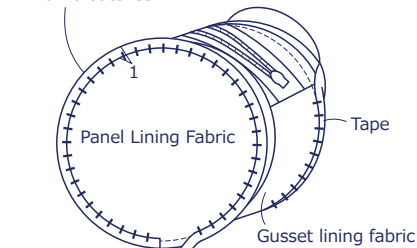

Fold for 1cm and overlap

- ③ Turn it inside out. Attach the handle using rivets.

