



# Short Sleeve Shirt for Kids

have fun with KOKKA fabric! produced by KOKKA

[kokka-fabric.com](http://kokka-fabric.com)

The craft projects and works featured in kokka-fabric.com are strictly for personal use and enjoyment. Please refrain from selling handmade items using the same exact design (including the pieces made in different fabrics) featured in kokka-fabric.com.

Design & work: Kokka Fabric

Size: 110cm

## Materials

- Outer fabric: 108cm wide x 110cm
- Fusible interfacing (light weight): 90cm wide x 60cm
- Button: Four pieces (13mm diameter)

Fabric shown for this sample: YPA-31020-1A

## Pattern and Cutting Layout

Unit: cm [ ]: Seam allowance

When cutting the fabric, add 1cm seam allowances unless otherwise stated.

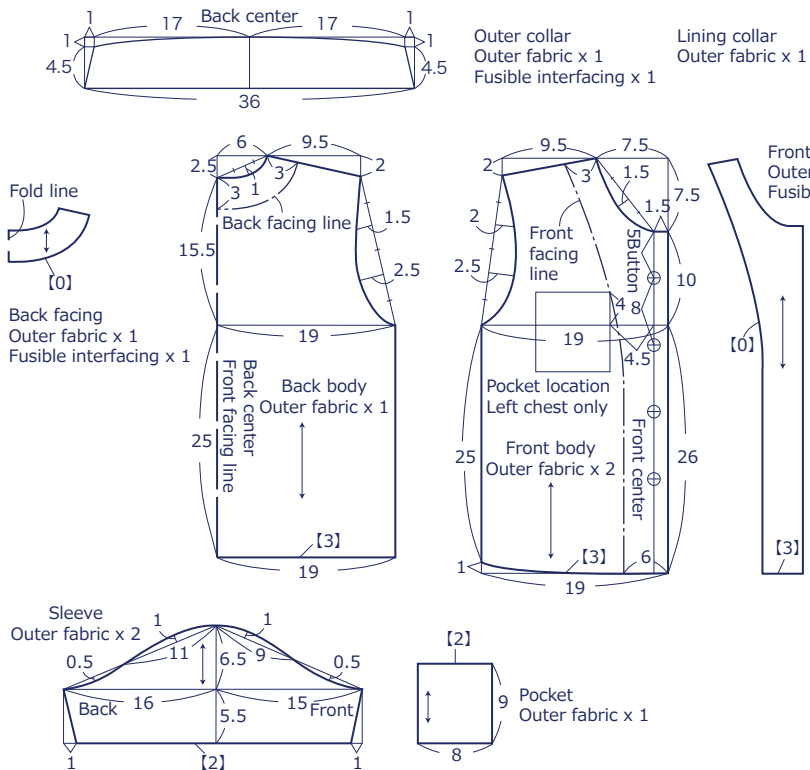

## Instructions

1. Adhere fusible interfacing on the back of the outer collar and front and back facings

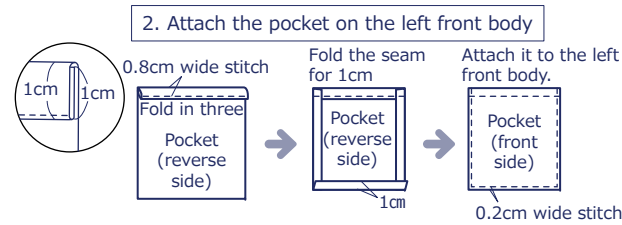

3. With the front sides facing each other, sew the collar

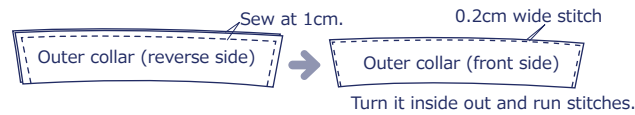

4. With the front sides facing each other, sew together the facing at the shoulder.

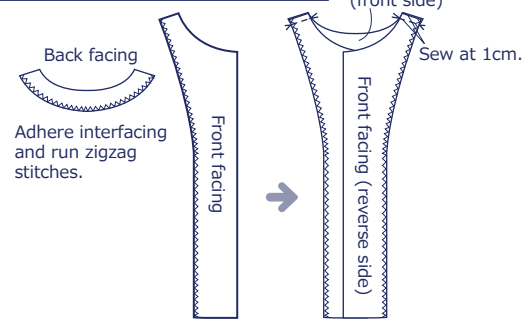

5. With the front sides facing each other, sew together the body at the shoulder

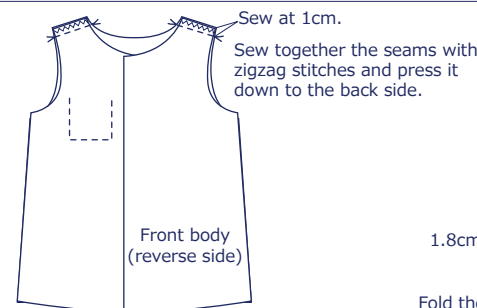

6. Place the collar in-between the body and facing and sew.

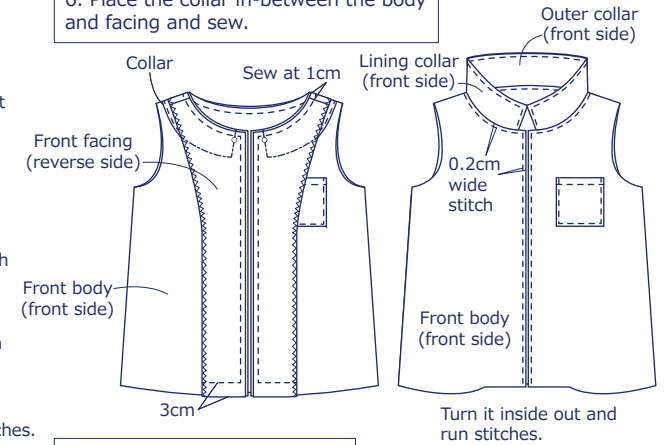

7. Finish the sleeves and sides

With the front sides facing each other, sew together the body and sleeve. Sew together the seams with zigzag stitches and press it down to the sleeve side.

With the front sides facing each other, sew all the way from the sleeve opening to the hem. Sew together the seams with zigzag stitches and press it down to the back side.

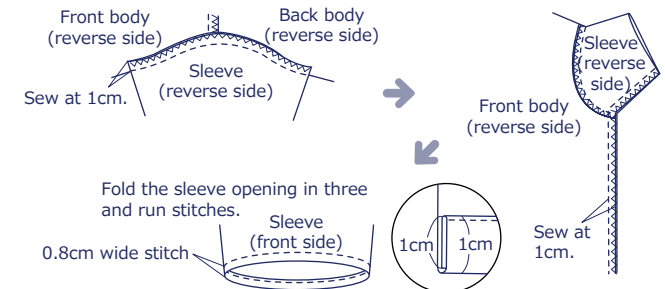

8. Fold the hem in three and run stitches

Make the button holes and attach buttons to finish.

