



One Handle Drawstring Reusable Bag

Design & work: Satomi Takei

Size: 41cm (l) 40cm (w) 10cm (d)

have fun with KOKKA fabric! produced by KOKKA

kokka-fabric.com

The craft projects and works featured in kokka-fabric.com are strictly for personal use and enjoyment. Please refrain from selling handmade items using the same exact design (including the pieces made in different fabrics) featured in kokka-fabric.com.

Materials

- Fabric (Main Body, Tag): 110cm wide x 50cm (Handle): 12cm x 65cm
- Artificial Leather (Cord Stopper): 4cm x 2cm
- Cord: 1.2m (0.2cm diameter)
- Rivet: One pair (0.7cm diameter)

Fabric shown for this sample: (Main Body, Tag) EKX-97600-600A

Pattern and Cutting Layout

Unit: cm All raw edge.

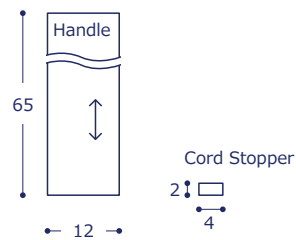
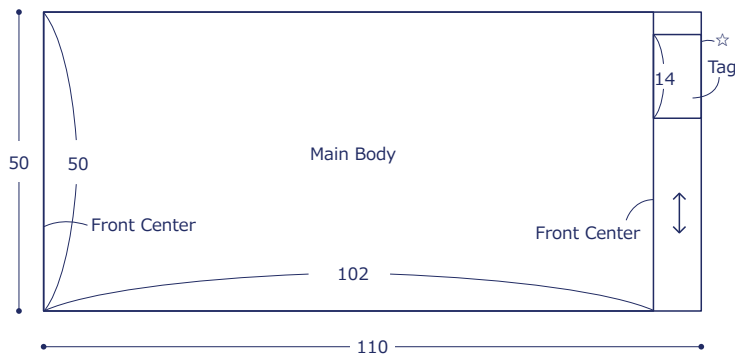

Instructions Front Side - (FrS), Reverse Side (RvS)

1. Make the main body

① With the front sides facing each other, fold in half and sew the front center, leaving a cord opening unsewn.

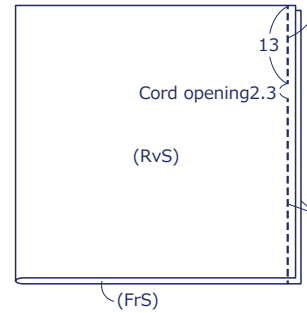

② Press the seam open and apply stitches from the front side.

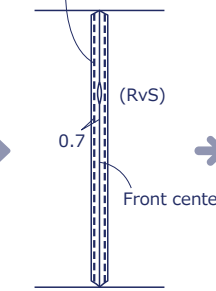

③ Fold the end of the opening side in three and sew.

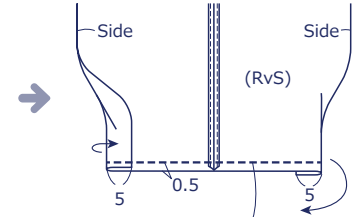
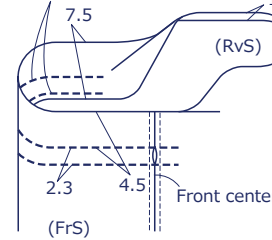

④ Turn it over to the reverse side. Fold the gusset and sew the bottom.

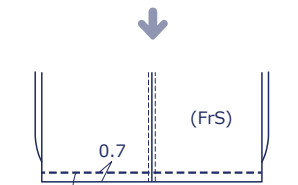

⑤ Turn it over to the front side and sew the bottom.

2. Make the handle

① Fold the end of three sides of the tag.

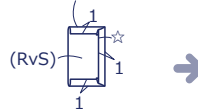

② Attach the tag.

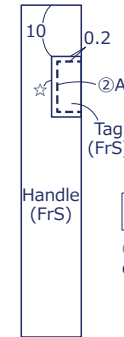

3. Finish the bag

① Insert the handle under the seam on the opening side and sew.

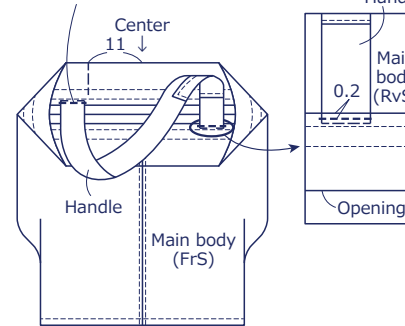

② Pull up the handle. Apply stitches over the stitch line from ①-③.

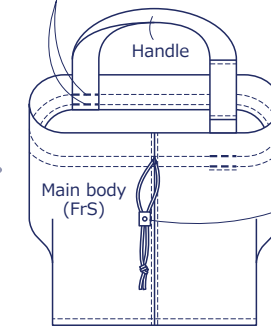

③ Insert the cord and attach the cord stopper.

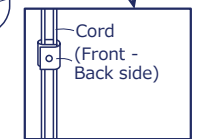

Fold in three and place the cord inside. Secure the center using a rivet, avoiding the cord.