



Bag Set (Shiba Inu)

Bag Set (Shiba Inu)

Design & work: Kokka Fabric

Size: Bag - about 24cm (l)/about 37cm (w) / about 8cm (d) (handles excluded)

Pouch - about 13cm (l) /about 13cm (w)/ about 3cm (d) (shoulder strap excluded)

Materials

- Fabric A: about 110cm wide x 50cm
- Fabric B: about 110cm wide x 80cm
- Fusible Quilt Batting: about 90cm wide x 60cm
- Bias Binding Tape: about 11mm wide x 50cm
- Tape: about 45mm wide x 110cm
- Zipper: 20cm x One piece
- Waxed Cord/String: about 5mm wide x 130cm

Fabric shown for this sample: (Fabric A: YPA-31000-2A, Fabric B: HA-3020-1A)

Pattern and Cutting Layout

Unit: cm Numbers in [] denote seam allowance.

Add 1cm seam allowance when cutting the fabric unless specified otherwise.

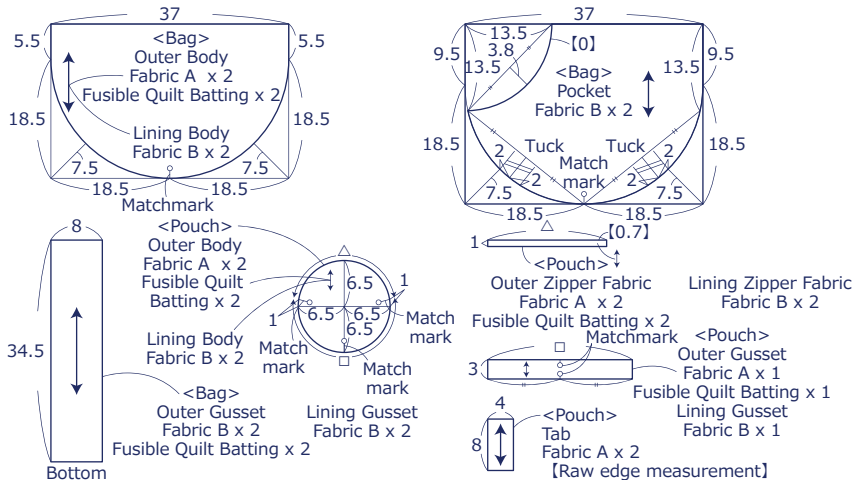

※Adhere fusible quilt batting on the back of the bag outer body and outer gusset, pouch outer body, outer zipper fabric and outer gusset.

<Fabric A - Sample Layout> about 110cm wide ※This is just an example.

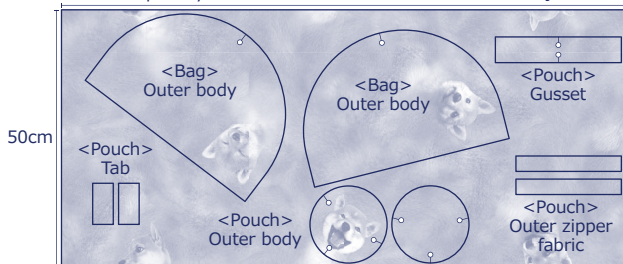

Instructions Front Side - (FrS), Reverse Side (RvS)

1. Wrap the top opening of the pocket with bias binding tape and apply stitches.

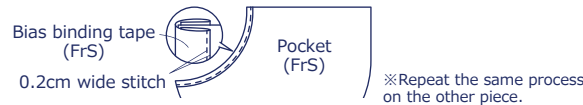

2. Fold the tuck on the pocket and baste



3. Fold the center of the tape in half and apply stitches

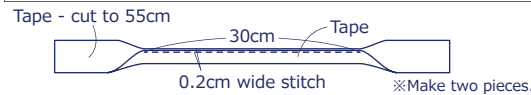

4. Baste the pocket and tape to bag outer body

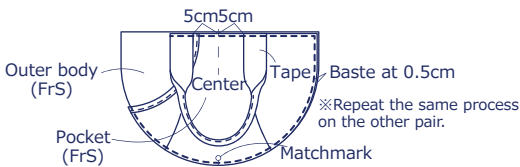

5. With the front sides facing each other, sew the gusset

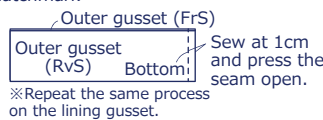

6. With the front sides facing each other, sew together the body and gusset

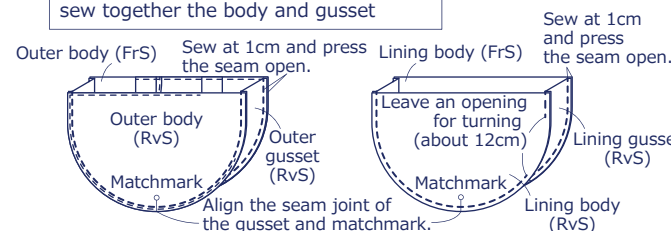

7. Sew together the outer body and lining body to finish the bag

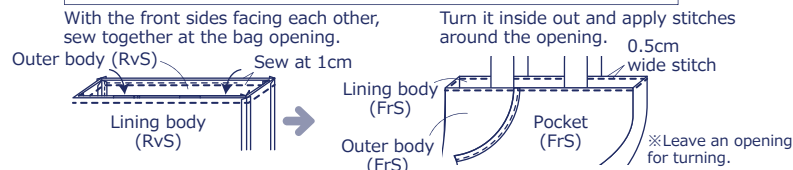

8. Sew together the zipper fabric and zipper

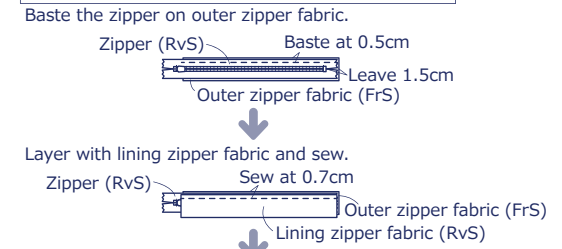

Turn it inside out and apply stitches. Baste the outer and lining zipper fabrics.

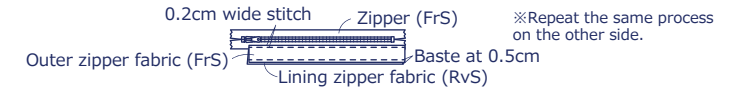

9. Sew together the zipper fabric and gusset

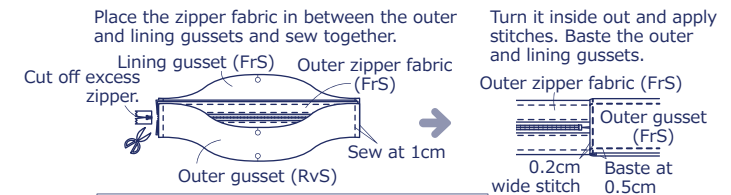

10. Make the tab and baste on the body

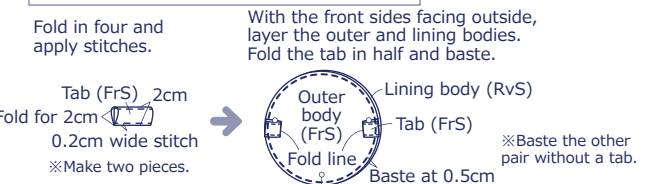

11. Sew together the body and gusset. Insert the waxed cord to finish the pouch

