



# Ribbon Pochette

Design & work: Satomi Takei

Size: 17cm (l)  
26cm (w - at opening) 22cm (bottom)  
4cm (gusset)

## Materials

- Fabric (Body Outer Fabric, Shoulder Strap, Ribbon, Tab, Tag): 110cm wide x 50cm (Body Lining Fabric (#11 Canvas)): 60cm x 30cm
- Fusible Quilt Batting: 29cm x 13cm
- Fusible Interfacing: 10cm x 10cm
- Magnetic Button (Hook Type): One pair (1.5cm diameter)

Fabric shown for this sample:

(Body Outer Fabric, Shoulder Strap, Ribbon, Tab, Tag) EGXA-9100-4A

## Pattern and Cutting Layout

Unit: cm All raw edge.

Use body outer fabric's measurement when cutting two pieces of body lining fabric.

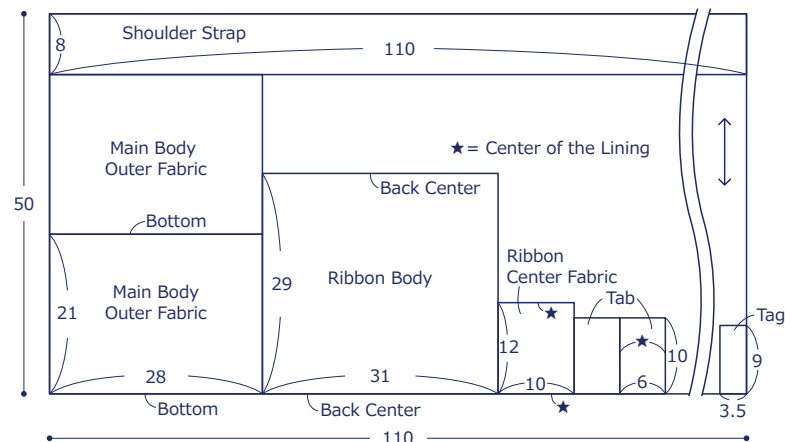

① With the front sides facing each other, fold the body lining fabric in half. Sew both ends, leaving an opening for turning.

### 1. Make the main body outer fabric

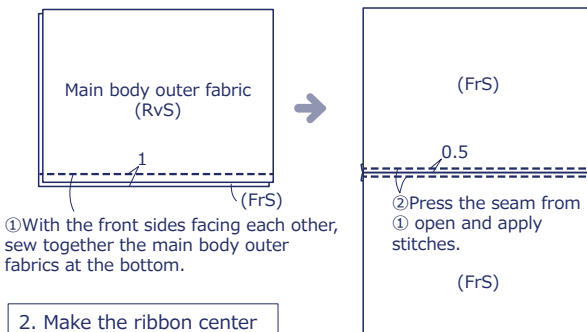

### 2. Make the ribbon center fabric and tab

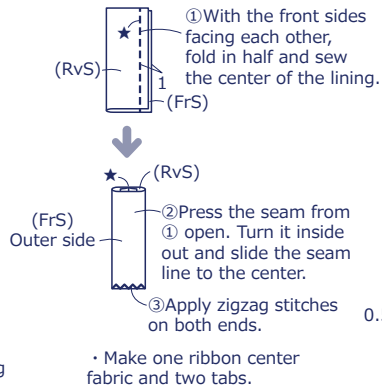

### 4. Make the lining bag

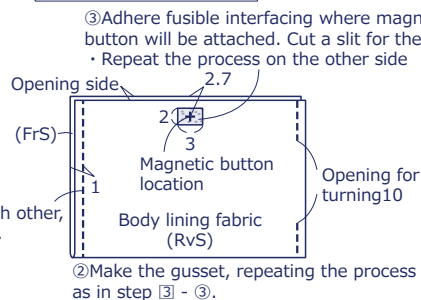

### 3. Make the outer bag

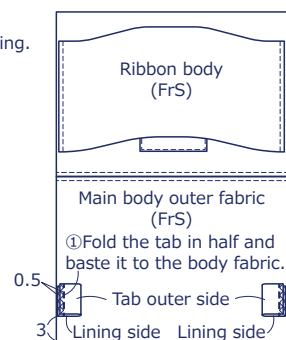

### 5. Finish the process

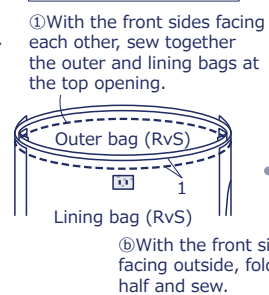

### ③ Make the ribbon body.

① With the front sides facing each other, fold in half and sew the back center.

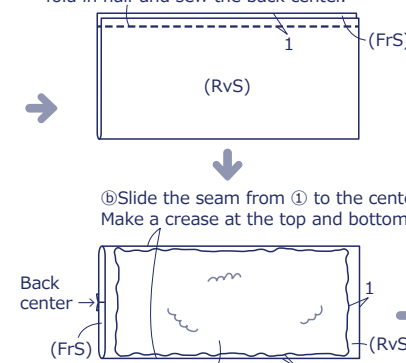

### ④ Turn over the piece from ③ and baste it to the main body outer fabric.

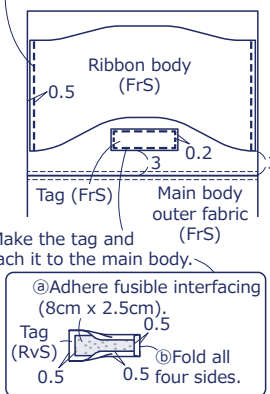

### ③ Adhere fusible quilt batting.

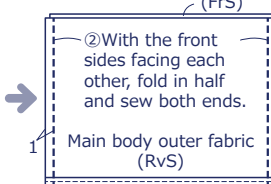

### ③ Make the gusset.

