



Two Way Tote Bag

Design & work: Mioko Sugino

Size: 21cm (l)
36cm (w - at opening) 26cm (bottom)
10cm (gusset)

have fun with KOKKA fabric! produced by KOKKA

kokka-fabric.com

The craft projects and works featured in kokka-fabric.com are strictly for personal use and enjoyment. Please refrain from selling handmade items using the same exact design (including the pieces made in different fabrics) featured in kokka-fabric.com.

Materials

- Fabric (Panel, Pocket, Tab, Loop): 100cm x 25cm
- Fabric (Lining Fabric, Opening Fabric, Bottom Fabric(#9.5 canvas)): 80cm x 55cm
- Bag Tape: 2.5cm wide x 2m
- D Ring, Swivel Hook: 2.5cm (inner diameter) x two pieces each
- Adjustable Slide Buckle: 2.5cm (inner diameter) x one piece
- Magnetic Hook (sew on type): 1.5cm (diameter) x one pair

Fabric shown for this sample: (Panel, Pocket, Tab, Loop) EKK-1300-1C

Pattern and Cutting Layout

Unit: cm All raw edge ★=attachment side

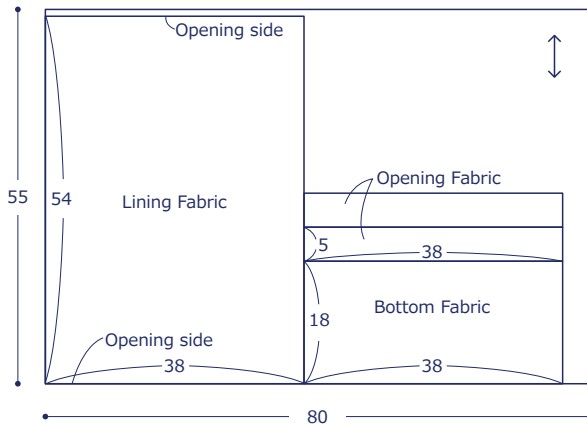
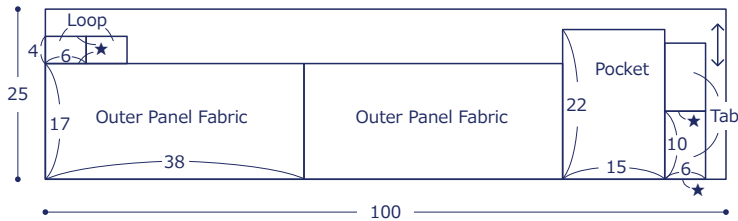

Instructions Front Side - (FrS), Reverse Side (RvS)

1. Make the outer fabric

① With the front sides facing each other, sew each part.

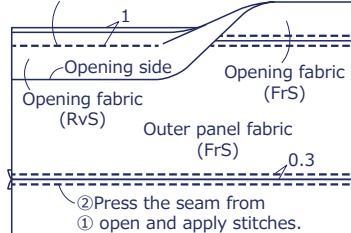

② Press the seam from ① open and apply stitches.

2. Make the pocket

① With the front sides facing each other, fold in half and sew, leaving an opening for turning.

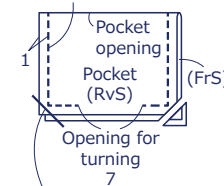

② Cut off the bottom corner seam.

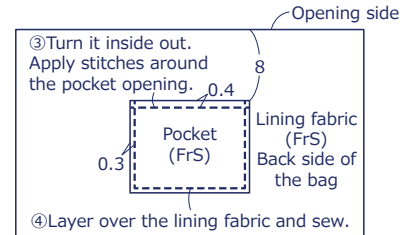

④ Layer over the lining fabric and sew.

3. Make the outer bag

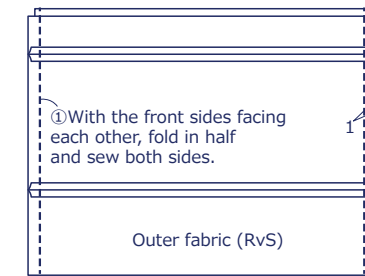

① With the front sides facing each other, fold in half and sew both sides.

② Fold the bottom corner into a triangle and sew the gusset.

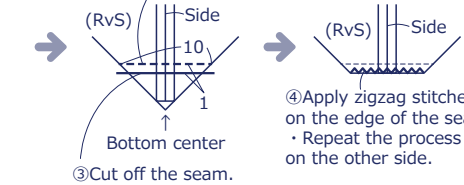

③ Cut off the seam.

4. Make the lining bag

Using the lining fabric, repeat step ③.

5. Make the loop

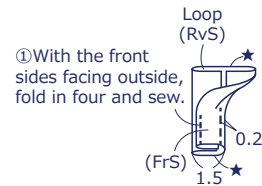

① With the front sides facing outside, fold in four and sew.



② Insert the loop through D ring and fold in half. Apply zigzag stitches on the end.
• Make two pieces.

6. Make the tab

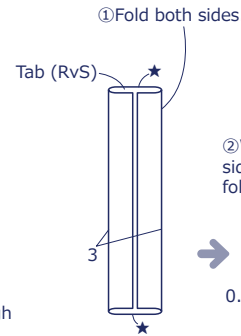

① Fold both sides.

② With the front sides facing outside, fold in half and sew.

• Make two pieces.

7. Finish the bag

① Fold the opening side of the outer bag and lining bag.

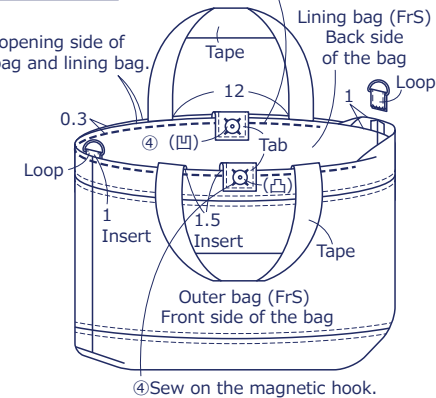

④ Sew on the magnetic hook.

② Place the tape (32cm each), tab and loop in between the bags and sew.

⑥ Insert the tape (136cm) through the swivel hook and adjustable slide buckle and sew.

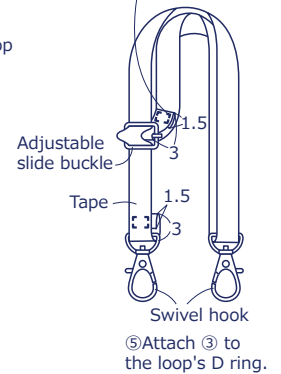

⑤ Attach ③ to the loop's D ring.