



# One-Handle Bag

Design & work: Yui Tamaki

Size: 35cm (l)  
25cm (w-at opening)  
35cm (bottom)

have fun with KOKKA fabric! produced by KOKKA

[kokka-fabric.com](http://kokka-fabric.com)

The craft projects and works featured in kokka-fabric.com are strictly for personal use and enjoyment. Please refrain from selling handmade items using the same exact design (including the pieces made in different fabrics) featured in kokka-fabric.com.

## Materials

- Fabric (Outer Fabric, Pocket): 100cm x 40cm
- Fabric (Lining Fabric): 80cm x 40cm
- Tape: 3.8cm wide x 1.3m
- Tag of your choice: One piece

Fabric shown for this sample: YGA-59040-2A

## Pattern and Cutting Layout

Unit: cm 1cm Seam Allowance  
Use outer fabric's measurement when cutting two pieces of lining fabric.

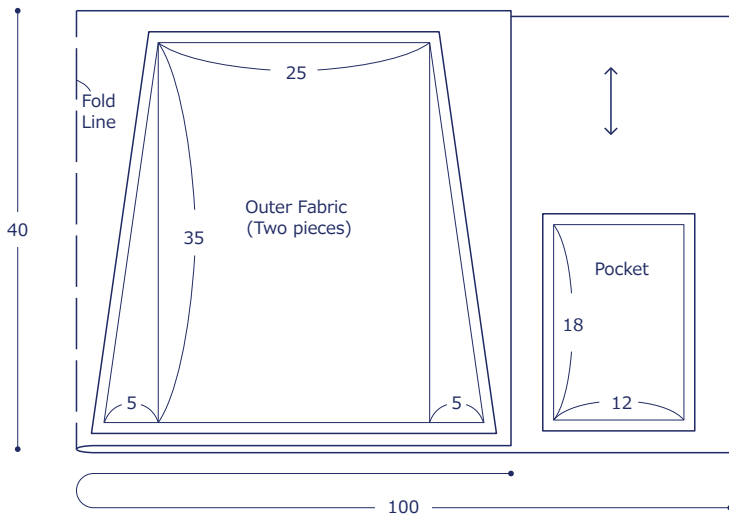

## Instructions Front Side - (FrS), Reverse Side (RvS)

### 1. Make the shoulder strap

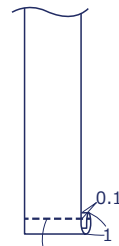

Fold the end of the tape in three and sew.

### 2. Make the pocket

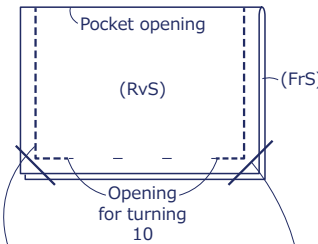

① With the front sides facing each other, fold in half and sew, leaving an opening for turning.

② Cut off bottom corner seam.

③ Turn it inside out.

### 3. Attach the pocket

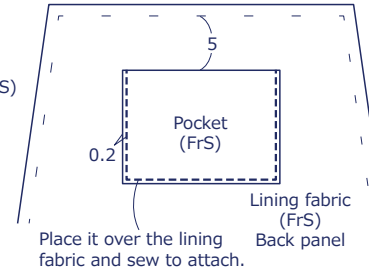

Place it over the lining fabric and sew to attach.

### 4. Attach the tag

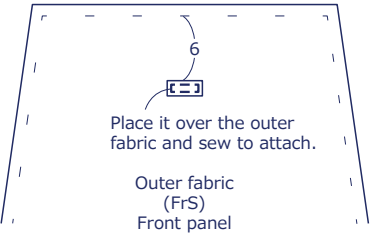

Place it over the outer fabric and sew to attach.

### 5. Make the front bag panel and back bag panel

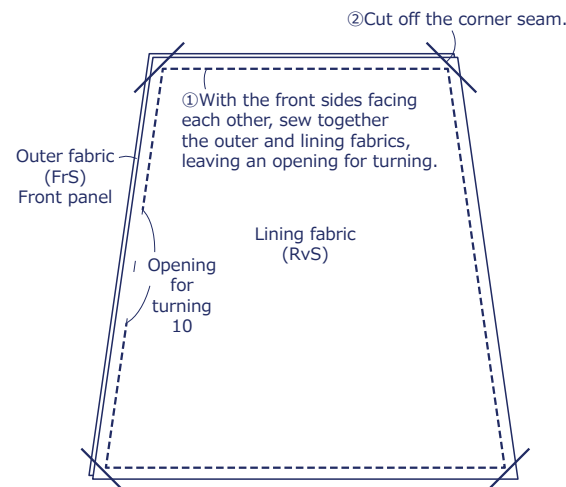

① With the front sides facing each other, sew together the outer and lining fabrics, leaving an opening for turning.

③ Turn it inside out.

※ Repeat the same process for the back side.

### 6. Finish the bag

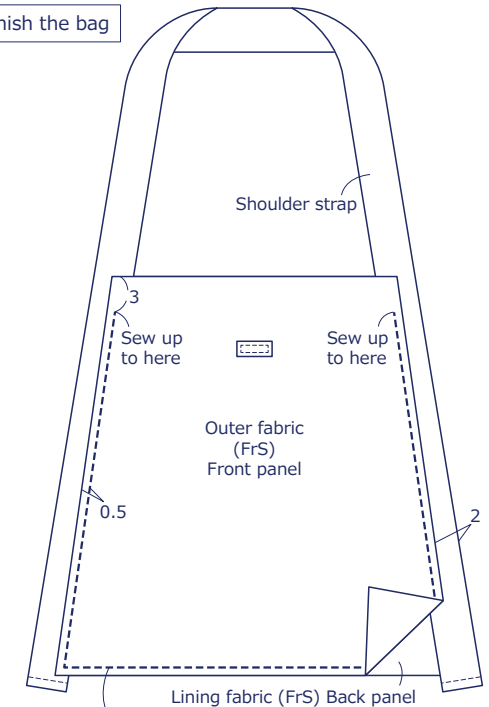

With the front sides facing outside, put together the front panel and back panel and sew with the shoulder strap in between.