



Shoulder Gather Dress

Design & work: Kokka Fabric

Size: M

Materials

- Outer fabric: 110cm wide x 350cm
- Fusible interfacing: 90cm wide x 30cm
- Button: 1.1cm wide x 10

Fabric shown for this sample: YGA-61000-2A

Pattern

Unit: Centimeters (cm) []: Seam allowance
Add 1cm seam allowance when you cut the fabric unless otherwise stated.

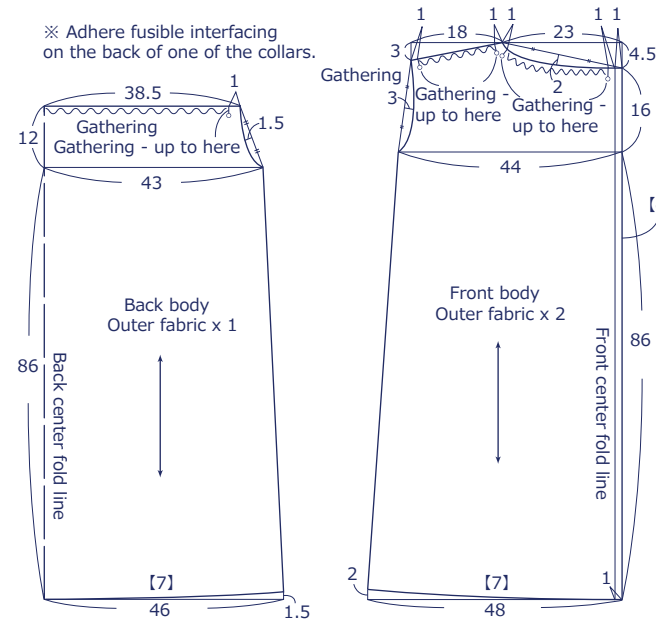
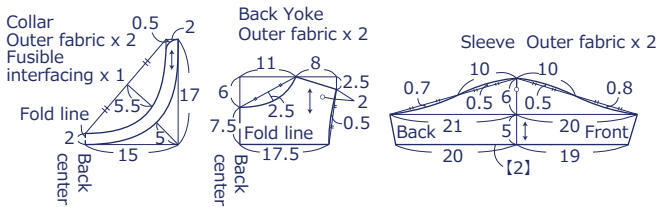

Instructions

1. Make the gathering on the body

Run rough stitches by hand or by machine. Pull the thread to create the gathering.

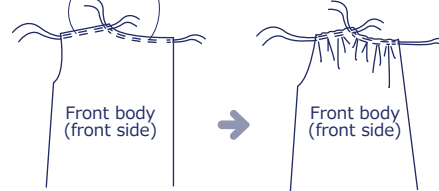

※ Repeat the gathering process on the back body.

2. Sew together the body and yoke

With the front sides facing each other, sew together the body and yoke.

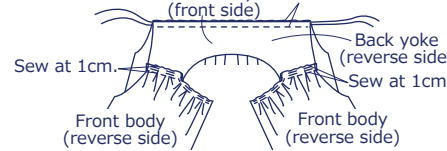

Fold the other back yoke at the finish line. Layer it over the pre-sewn back yoke and sew together.

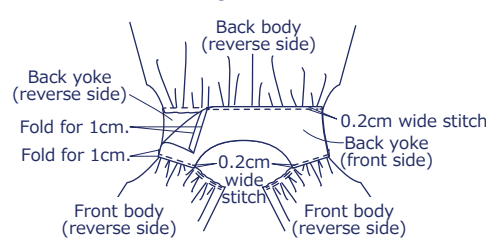

3. With the front sides facing each other, sew together the body and sleeve, and sew at the side.

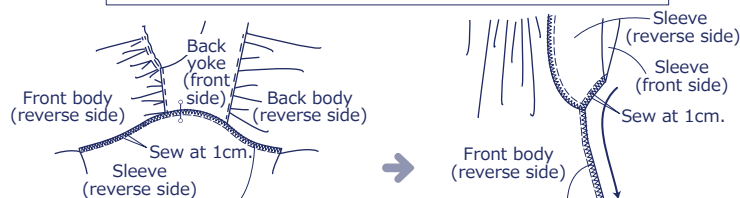

Sew together the seams and run zigzag stitches. Press it down to the body side.

Sew together the seams and run zigzag stitches. Press it down to the back side.

4. Fold the sleeve opening, hem and front edge in three and run stitches

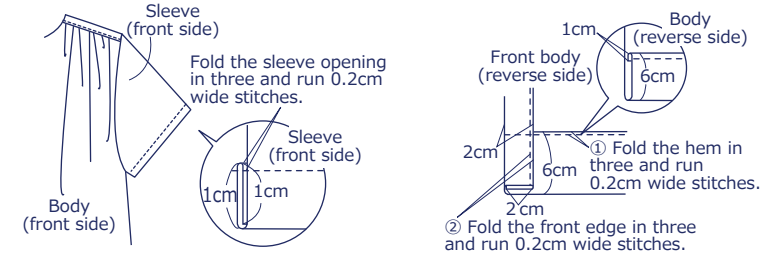

5. Make the collar and sew together with the body

Fold the seam of one of the collars. With the front sides facing each other, sew together the collar pieces. With the front sides facing each other, sew together the body and collar around the edge of the collar.

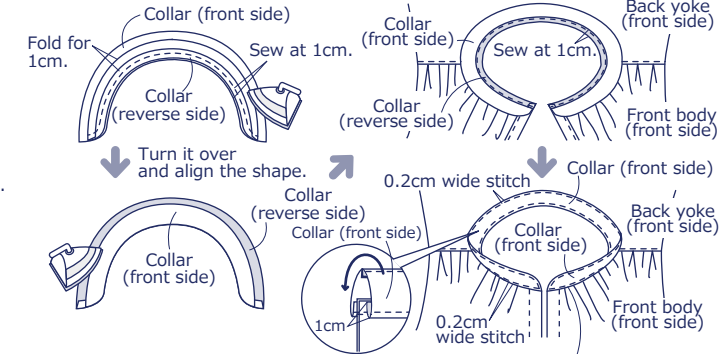

※ If you find it difficult to sew, then baste it first.

6. Attach the buttons and make the button holes

