

Two-Way Handbag

Design & work: Mioko Sugino

Size: 19cm (l)
 34cm (w - at opening) 24cm (bottom)
 10cm (gusset)



Materials

- Fabric (Outer Fabric): 80cm x 25cm
 (Lining Fabric, Bottom Fabric, Handle, Flap): 100cm x 50cm
- Plasnab Button: 1.3cm diameter x One pair

Fabric shown for this sample: (Outer Fabric) EGXA-9200-2D

Pattern and Cutting Layout

Unit: cm All raw edge

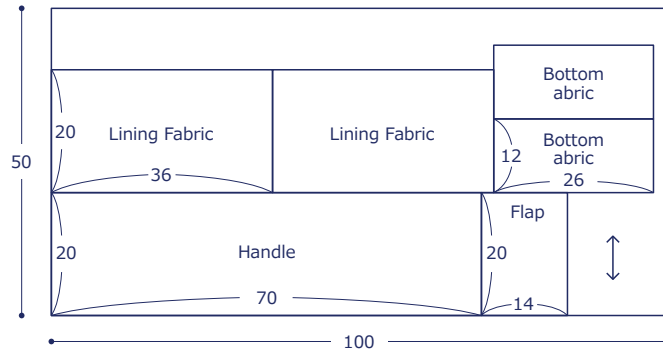
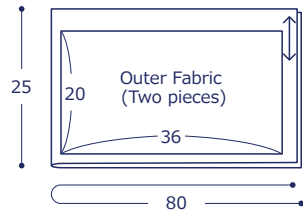

have fun with KOKKA fabric! produced by KOKKA

kokka-fabric.com

The craft projects and works featured in kokka-fabric.com are strictly for personal use and enjoyment. Please refrain from selling handmade items using the same exact design (including the pieces made in different fabrics) featured in kokka-fabric.com.

Instructions Front Side - (FrS), Reverse Side (RvS)

1. Make the outer bag

① With the front sides facing each other, sew together the outer fabrics at the sides. (FrS)

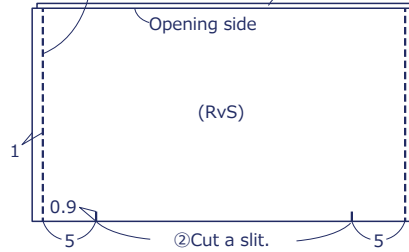

④ Fold the edge of the opening side.

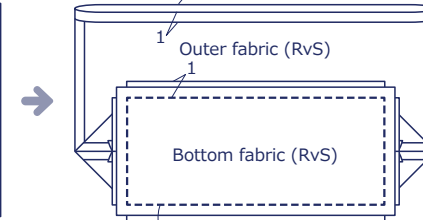

③ With the front sides facing each other, sew together the piece from ② and bottom fabric.

2. Make the lining bag

Using the lining fabric and bottom fabric, repeat step ①.

3. Sew together the outer bag and lining bag

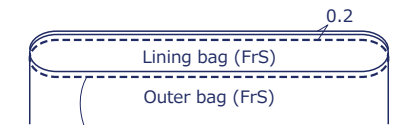

With the front sides facing outside, sew together the outer and lining bags at the top opening.

4. Make the flap

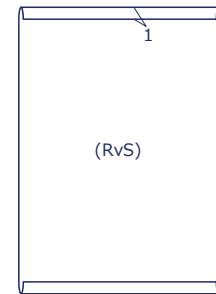

① Fold the edge of the short end.

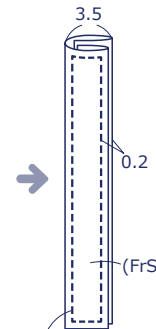

② With the front sides facing outside, fold in four and sew.

5. Make the handle

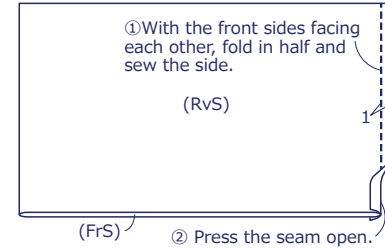

① With the front sides facing each other, fold in half and sew the side. (RvS)

② Press the seam open. (FrS)

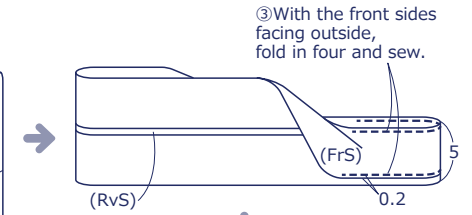

③ With the front sides facing outside, fold in four and sew. (FrS)

④ Layer the piece from ③ over the lining bag and sew. (FrS)

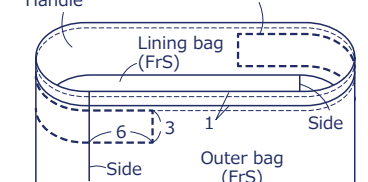

6. Finish the bag

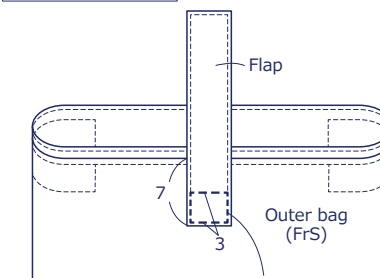

① Layer the flap over the outer bag and sew. (FrS)

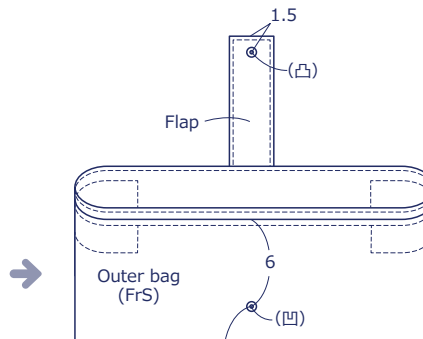

② Attach the Plasnab button. (FrS)