



Double Pocket Bag

Design & work: Mioko Sugino

Size: 20cm (l)
32cm (w-at opening) 24cm (bottom)
8cm (gusset)

Materials

- Fabric (Body Lining Fabric, Pocket, Handle Lining Fabric, Flap): 90cm x 70cm
(Body Outer Fabric, Handle Outer Fabric): 40cm x 50cm
- Zipper: One piece (width 2.4cm, length 20cm)
- Plasnapp button: One pair (1.3cm diameter)

Fabric shown for this sample: (Body Lining Fabric, Pocket, Handle Lining Fabric, Flap) YKA-21050-2A

Pattern and Cutting Layout

Unit: cm All raw edge

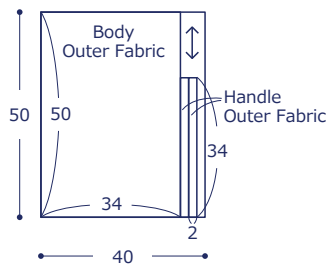
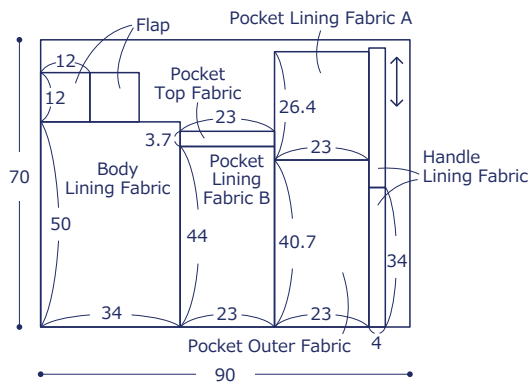

Instructions Front Side - (FrS), Reverse Side (RvS)

1. Make the pocket

①With the front sides facing each other, baste the outer fabric and zipper.

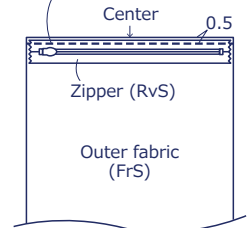

②With the front sides facing each other, sew together the outer fabric and lining fabric A.

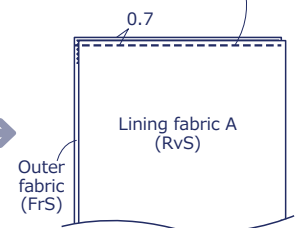

③Turn the zipper over to the front side. With the front sides facing outside, baste together with lining fabric A.

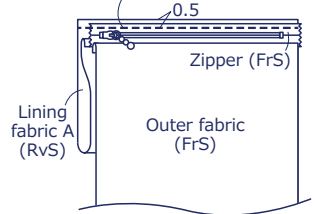

④With the front sides facing each other, sew together the top fabric and zipper. Turn it over.

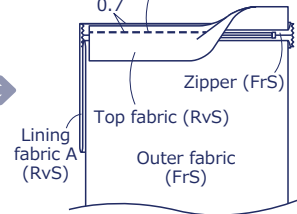

⑤With the front sides facing each other, sew together the outer fabric and lining fabric B, leaving an opening for turning.

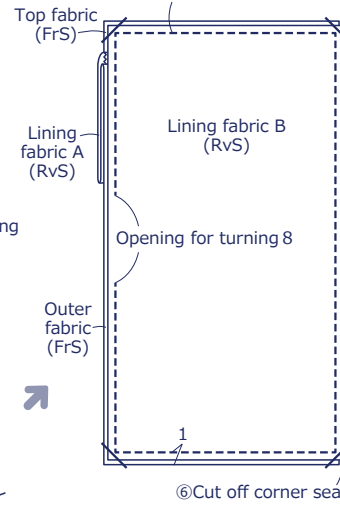

⑥Cut off corner seam.

⑦Turn it inside out and apply stitches around pocket opening.

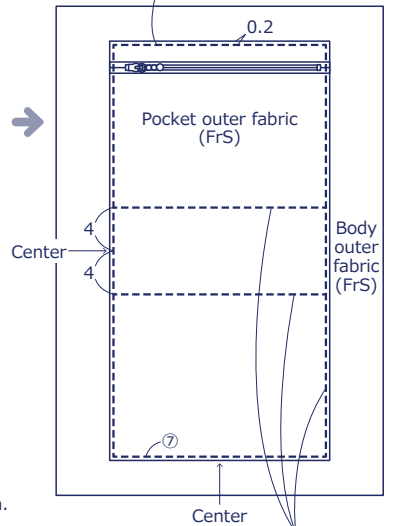

⑧Layer it over body outer fabric and sew both sides and bottom.

2. Make the body

①Make the outer bag.

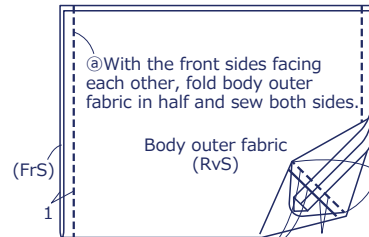

②With the front sides facing each other, fold body outer fabric in half and sew both sides.

③Fold bottom corner into a triangle. Sew the gusset and cut off excess seam.



④Apply zigzag stitches on the gusset seam. Repeat the same process on the other side.

④Fold the top opening. (Repeat the same for outer bag.)

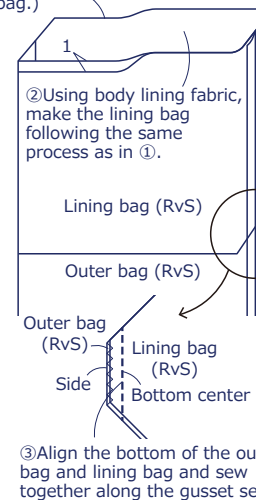

③Align the bottom of the outer bag and lining bag and sew together along the gusset seam.

3. Make the handle and flap

<Handle>
Lining fabric (RvS)

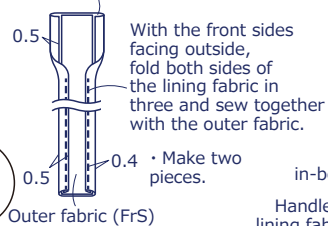

<Flap>
①Fold both ends.

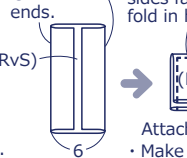

②With the front sides facing outside, fold in half and sew.

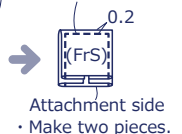

4. Finish the bag

①With the front sides facing outside, sew together the outer and lining bags at the top opening with the handle and flap placed in-between.

