



Wrap Skirt

Design & Work: Yoko Kato

Size: Length 83cm

Materials

- Fabric: 110cm wide x 2.5m
- Fusible Interfacing: 75cm x 40cm

Fabric shown for this sample: EKX114-1J

Pattern

Unit: cm ※Sixteen (16) tucks in total.

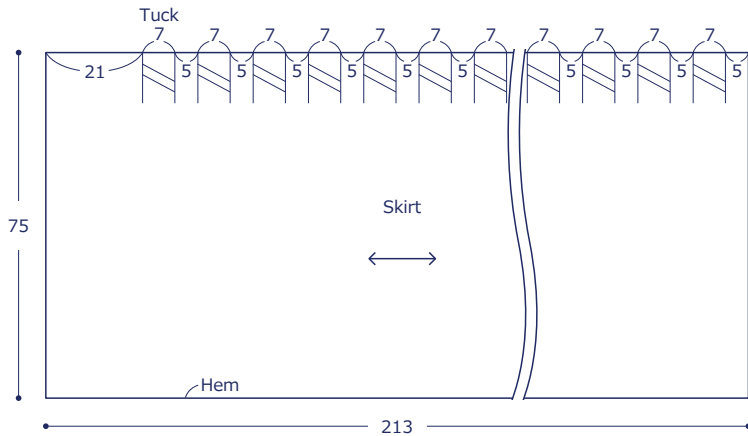

Cutting Layout

[] denotes seam allowance. Add 1cm unless specified otherwise.
Adhere fusible interfacing on the back of Yoke A and B.

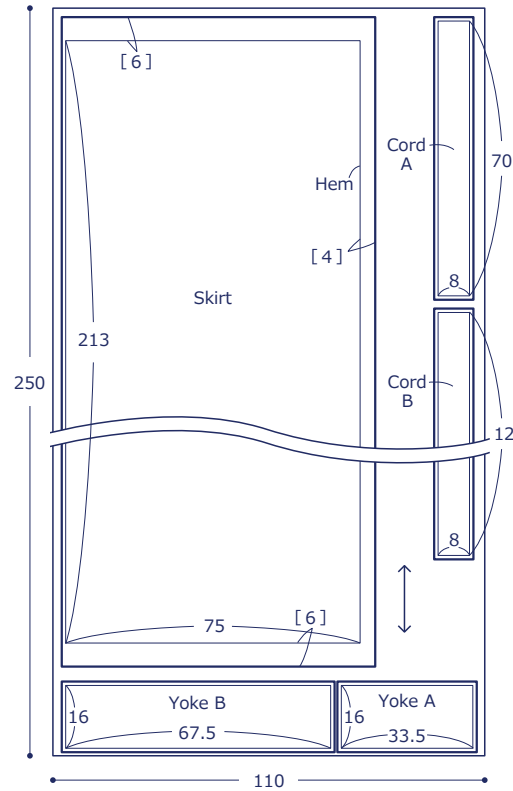

4. Finish the skirt

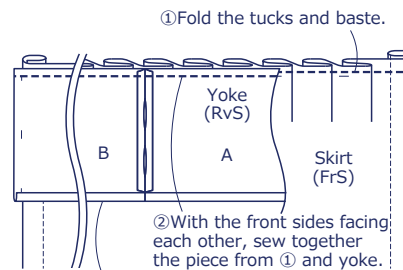

③Fold the seam of the yoke.

have fun with KOKKA fabric! produced by KOKKA
kokka-fabric.com

The craft projects and works featured in kokka-fabric.com are strictly for personal use and enjoyment. Please refrain from selling handmade items using the same exact design (including the pieces made in different fabrics) featured in kokka-fabric.com.

Instructions Front Side - (FrS), Reverse Side - (RvS)

1. Sew the hem and both sides

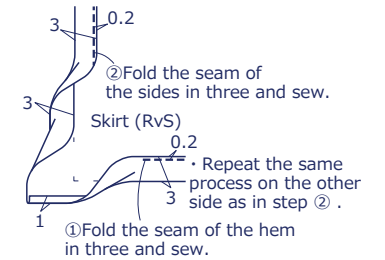
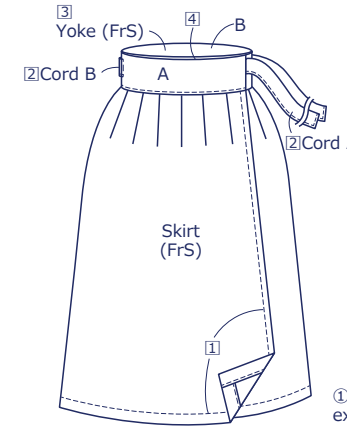

2. Make the cord

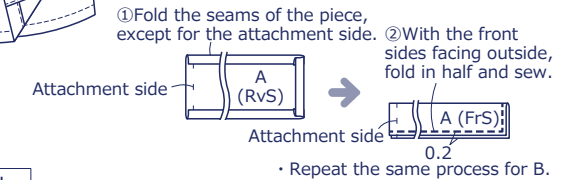

3. Make the yoke

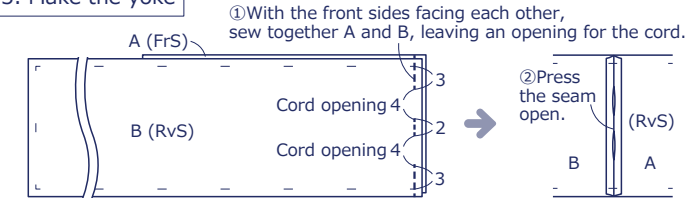

⑤Turn the yoke over to the front, and sew with seam from ② tucked in.

⑥Apply stitches around the cord opening.

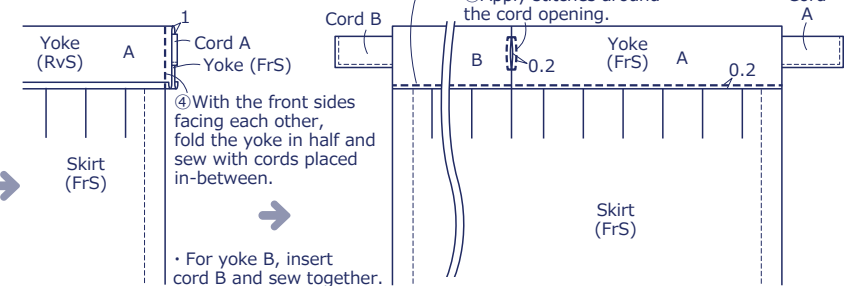

④With the front sides facing each other, fold the yoke in half and sew with cords placed in-between.
• For yoke B, insert cord B and sew together.