



Mini Shoulder Bag

Design & work: Kokka Fabric

Size: 16cm (l) x 16cm (w) x 4cm (d)

※Excludes shoulder strap

have fun with KOKKA fabric! produced by KOKKA

kokka-fabric.com

The craft projects and works featured in kokka-fabric.com are strictly for personal use and enjoyment. Please refrain from selling handmade items using the same exact design (including the pieces made in different fabrics) featured in kokka-fabric.com.

Materials

- Fabric 70cm x at least 110cm wide
- Fusible interfacing 50cm x at least 90cm wide

Fabric shown for this sample: YG-76020-1B

Pattern

Unit: cm [] : Seam Allowance
Add 1cm seam unless otherwise stated when cutting the fabric.

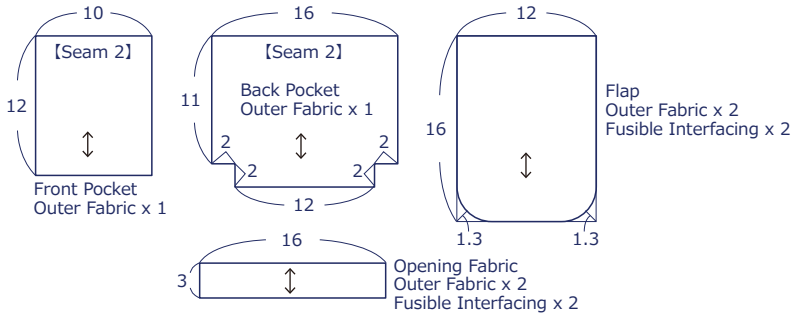

Bag Fabric - Side Outer Fabric x 2, Fusible Interfacing x 2 (3x13)

Bag Fabric - Front Outer Fabric x 1, Fusible Interfacing (10x15)

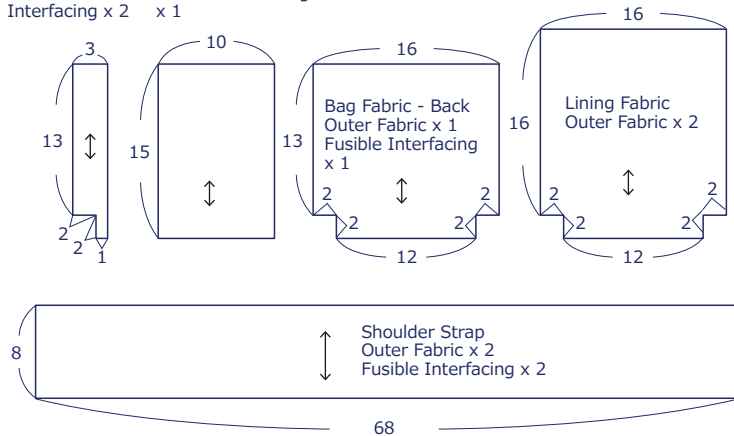

Instructions

Front Side - (FrS), Reverse Side (RvS)

1. Attach fusible interfacing on the back of the fabrics. (Flap, Opening fabric, Bag fabrics - sides, front and back, Shoulder strap)

2. Make the shoulder strap

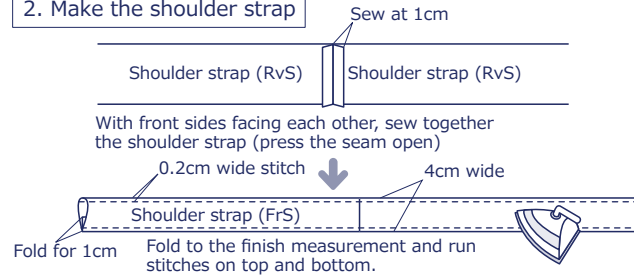

3. Make the flap

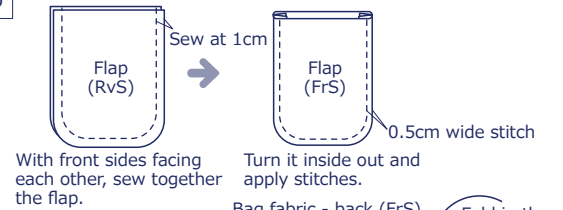

4. Make the pocket

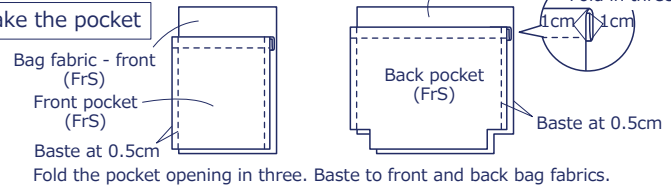

5. Prepare the bag fabrics

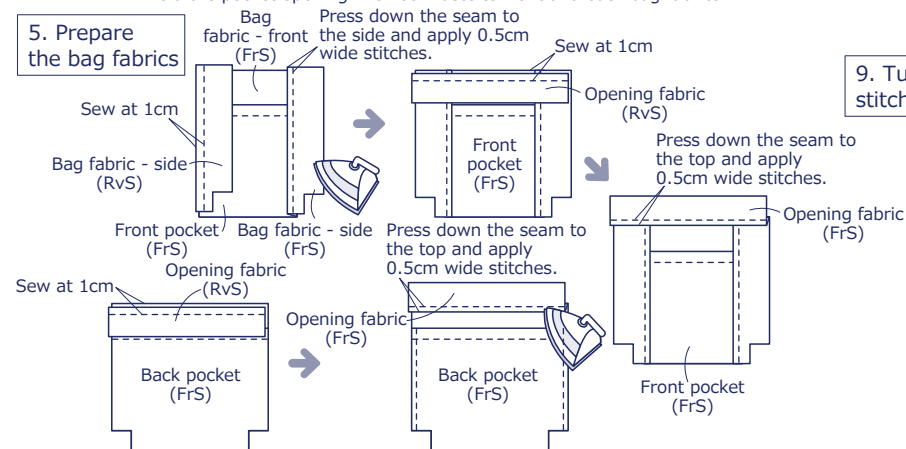

6. Sew the sides, bottom and gusset

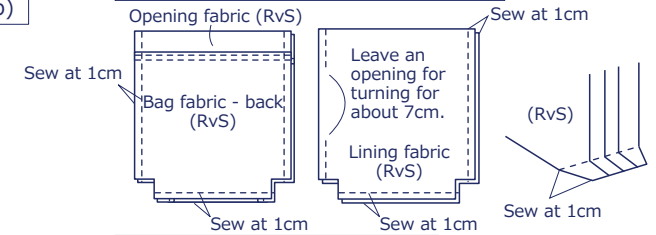

7. Baste the flap and shoulder strap to the opening fabric.

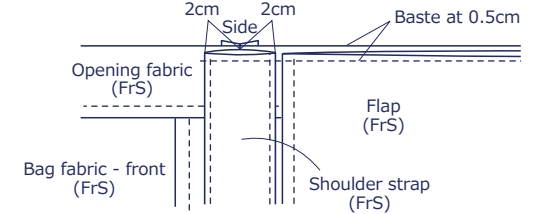

8. With front sides facing each other, sew together the bag fabric and lining fabric at the top opening

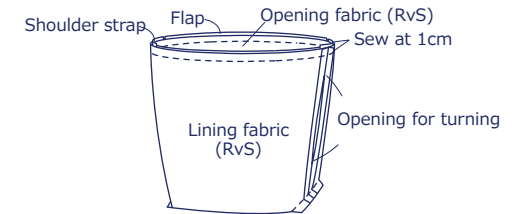

9. Turn the bag inside out and apply top stitches around the opening to finish

